



# Hardware Installation and Configuration Guide



### ***Trademark Notices***

Control, DeviceMaster, and PortVision are registered trademarks of Comtrol Corporation.

Ethernet is a registered trademark of Digital Equipment Corporation, Intel, and Xerox Corporation.

Microsoft and Windows are registered trademarks of Microsoft Corporation in the United States and/or other countries.

Modbus is a registered trademark of Schneider Electric.

PLC is a registered trademark of Allen-Bradley Company, Inc.

RedBoot is a trademark of Red Hat, Inc.

SIMATIC is a registered trademark of Siemens, AG.

Portions of SocketServer are copyrighted by GoAhead Software, Inc. Copyright © 2001. GoAhead Software, Inc. All Rights Reserved.

Other product names mentioned herein may be trademarks and/or registered trademarks of their respective owners.

Eleventh Edition, September 13, 2016

Copyright © 2005 - 2016. Comtrol Corporation.

All Rights Reserved.

Comtrol Corporation makes no representations or warranties with regard to the contents of this document or to the suitability of the Comtrol product for any particular purpose. Specifications subject to change without notice. Some software or features may not be available at the time of publication. Contact your reseller for current product information.

# Table of Contents

<b>Getting Started .....</b>	<b>7</b>
<b>Protocols Supported .....</b>	<b>7</b>
<b>Quick Start .....</b>	<b>7</b>
<b>Locating Software and Documentation .....</b>	<b>8</b>
<b>Hardware Installation.....</b>	<b>13</b>
<b>Installation Overview .....</b>	<b>13</b>
<b>1-Port - Panel Mount Installation .....</b>	<b>14</b>
<b>1-Port DIN Rail (Terminal Block) Installation .....</b>	<b>16</b>
<b>1-Port DIN Rail (DB9) Installation .....</b>	<b>17</b>
<b>2-Port (Terminal Block) 1E/2E Installation .....</b>	<b>19</b>
<b>2-Port (DB9) 1E/2E Installation .....</b>	<b>21</b>
<b>4-Port DIN Rail Models Installation.....</b>	<b>23</b>
<b>4-Port Installation .....</b>	<b>25</b>
<b>Adding a Unit to an Existing Installation.....</b>	<b>26</b>
<b>Replacing Hardware .....</b>	<b>26</b>
<b>Configuring the DeviceMaster UP .....</b>	<b>27</b>
<b>PortVision DX Overview .....</b>	<b>27</b>
<b>PortVision DX Requirements.....</b>	<b>28</b>
<b>Installing PortVision DX.....</b>	<b>28</b>
<b>Configuring the Network Settings .....</b>	<b>32</b>
<b>Checking the Protocol Firmware Version.....</b>	<b>35</b>
<b>Uploading Protocol-Specific Firmware on the DeviceMaster UP .....</b>	<b>36</b>
<b>Customizing PortVision DX .....</b>	<b>38</b>
<b>Accessing DeviceMaster UP Documentation from PortVision DX .....</b>	<b>39</b>
How to Download Documentation .....	39
How to Open Previously Downloaded Documents .....	40
<b>Connecting Serial Devices .....</b>	<b>41</b>
<b>DB9 Connectors .....</b>	<b>42</b>
DB9 Null-Modem Cables (RS-232) .....	43
DB9 Null-Modem Cables (RS-422) .....	43
DB9 Straight-Through Cables (RS-232/485).....	43
DB9 Loopback Plugs.....	44
Connecting DB9 Serial Devices .....	44
<b>RJ45 Connectors .....</b>	<b>45</b>
RJ45 Null-Modem Cables (RS-232) .....	45
RJ45 Null-Modem Cables (RS-422) .....	46
RJ45 Straight-Through Cables (RS-232/485).....	46
RJ45 Loopback Plugs.....	46
RJ45 RS-485 Test Cable.....	46
Connecting RJ45 Devices .....	47

- Screw Terminals (4) - DeviceMaster UP 2-Port 1E .....48**
  - Serial Terminal (4) Connectors ..... 48
  - Serial Terminal (4) Null-Modem Cables (RS-232) ..... 49
  - Serial Terminal (4) Null-Modem Cables (RS-422) ..... 49
  - Serial Terminal (4) Straight-Through Cables (RS-232/485) ..... 49
  - Serial Terminal (4) Loopback Signals ..... 50
  - Connecting Serial Devices ..... 50
- Screw Terminals (9) - DeviceMaster UP 1-Port (DIN Rail) .....51**
  - Screw Terminal Connectors (9)..... 51
  - Screw Terminal (9) Null-Modem RS-232 Cables ..... 51
  - Screw Terminal (9) Null-Modem RS-422 Cables ..... 52
  - Screw Terminal (9) RS-232/485 Straight-Through Cables..... 52
  - Screw Terminal (9) Loopback Signals ..... 52
  - Connecting Serial Devices ..... 53
- Managing the DeviceMaster UP .....55**
  - Rebooting the DeviceMaster UP .....55**
  - Uploading Firmware to Multiple DeviceMaster UPs.....56**
  - Configuring Multiple DeviceMaster UPs Network Addresses.....57**
  - Adding a New Device in PortVision DX .....57**
    - Remote Using the IP Address ..... 57
    - Local Using the IP Address or MAC Address ..... 58
  - Using Configuration Files .....59**
    - Saving a Configuration File ..... 59
    - Loading a Configuration File ..... 60
  - Managing Bootloader .....61**
    - Checking the Bootloader Version..... 61
    - Uploading Bootloader ..... 61
  - Restoring Factory Defaults (Specific Models) .....63**
  - Accessing RedBoot Commands in Telnet/SSH Sessions (PortVision DX) ..... 64**
- RedBoot Procedures.....67**
  - Accessing RedBoot Overview ..... 67**
  - Establishing a Serial Connection ..... 68**
  - Establishing a Telnet Connection..... 69**
  - Determining the Network Settings ..... 70**
  - Configuring the Network Settings ..... 70**
  - Changing the Bootloader Timeout ..... 71**
  - Determining the Bootloader Version..... 71**
  - Resetting the DeviceMaster UP ..... 72**
  - Configuring Passwords ..... 72**
  - RedBoot Command Overview..... 73**

---

<b>Hardware Specifications</b> .....	<b>77</b>
<b>Locating DeviceMaster UP Specifications</b> .....	<b>77</b>
<b>External Power Supply Specifications</b> .....	<b>78</b>
1-Port Panel Mount 5-30VDC Power Supply .....	78
1-Port DIN Rail Power Supply .....	79
2-Port (Serial Terminals) Power Supply .....	79
2-Port (DB9) Power Supply .....	80
4-Port DIN Rail Models Power Supply .....	80
4-Port Panel Mount Power Supply .....	81
<b>DeviceMaster UP Product Pictures</b> .....	<b>81</b>
1-Port (DB9) .....	81
1-Port DIN Rail (Screw Terminal) .....	82
1-Port DIN Rail (DB9) .....	82
2-Port Terminal Block (Single Ethernet Port) .....	83
2-Port Terminal Block (Dual Ethernet Ports) .....	83
2-Port DB9 (Single Ethernet Port) .....	83
2-Port DB9 (Dual Ethernet Ports) .....	84
4-Port DIN Rail (DB9) .....	84
4-Port (DB9) .....	84
<b>Troubleshooting and Technical Support</b> .....	<b>85</b>
<b>Troubleshooting Checklist</b> .....	<b>85</b>
<b>General Troubleshooting</b> .....	<b>87</b>
<b>Daisy-Chaining DeviceMaster UP 2E/4-Port Units</b> .....	<b>88</b>
<b>DeviceMaster UP LEDs</b> .....	<b>89</b>
TX/RX LEDs .....	89
Network and Device LEDs .....	89
<b>Technical Support</b> .....	<b>91</b>



# Getting Started

This guide discusses initial DeviceMaster UP installation and hardware configuration for the DeviceMaster UP.

This guide does not discuss configuring the port characteristics or protocol-specific programming information. See [Locating Software and Documentation](#) on Page 8 to locate the firmware and the appropriate documentation for your environment.

**Note:** *If you have a DeviceMaster UP with 16-ports, use the [DeviceMaster UP 16-Port Hardware User Guide](#) because the RJ45 connectors have different pin outs.*

---

---

## Protocols Supported

The DeviceMaster UP is a network attached, solid-state 1 or 4-port device server, which hosts an Industrial Ethernet engine and translates device communications to a programmable logic controller (PLC) and any serial device.

Depending on the model you purchased, the DeviceMaster UP may or may not have the protocol firmware loaded.

**Note:** *Models that have a protocol loaded on the DeviceMaster UP are identified in PortVision DX and the DeviceMaster UP is labeled accordingly.*

When the DeviceMaster UP is loaded with the appropriate firmware for your DeviceMaster UP, it enables connectivity between any PLC and any serial device. The DeviceMaster UP supports the following protocols:

- EtherNet/IP
- Modbus Router
- Modbus Server
- Modbus/TCP
- PROFINET IO

---

---

## Quick Start



Installation and configuration follows these steps.

1. Connect the hardware (Page 13).
2. Install PortVision DX (Page 28).
3. Configure the DeviceMaster UP network settings (Page 32).
4. If necessary, install or update the firmware on the DeviceMaster UP for your protocol (Page 36).
5. Use [Locating Software and Documentation](#) on Page 8 to locate the appropriate installation document for your protocol so that you can perform the following procedures:
  - Configure port characteristics using the *Server Configuration* web page.
  - Program the PLCs.
6. Connect the serial device or devices (Page 41).



## Locating Software and Documentation



You can access the appropriate firmware assembly, PortVision DX, and the *DeviceMaster UP* documentation from the CD shipped with the DeviceMaster UP or you can download the latest files using the links in the appropriate table:



- Software and firmware, which is independent of the protocol loaded (below)
- [EtherNet/IP Firmware and Documentation](#) on Page 9
- [Modbus Router Firmware and Documentation](#) on Page 9
- [Modbus Server Firmware and Documentation](#) on Page 10
- [Modbus/TCP Firmware and Documentation](#) on Page 10
- [PROFINET IO Firmware and Documentation](#) on Page 11



DeviceMaster UP Software and Firmware		Link
PortVision DX	<p><i>PortVision DX</i> is the application for Windows that you use to configure network settings and upload the firmware for your protocol.</p> <p>Use PortVision DX to manage Control Ethernet-attached devices to:</p> <ul style="list-style-type: none"> <li>• Scan the network for attached devices</li> <li>• View networked devices in real-time</li> <li>• Access product-specific network settings configurations</li> <li>• Assign IP addresses and network settings to one or multiple devices</li> <li>• Upload the latest firmware or Bootloader</li> <li>• Save and load configuration files</li> <li>• Access DeviceMaster UP configuration web pages</li> <li>• Access Telnet/SSH sessions</li> <li>• Remotely reboot devices</li> <li>• Download technical documentation</li> <li>• Enable event logging to assist in monitoring and troubleshooting</li> <li>• Create shortcuts to quickly access your favorite applications</li> <li>• Organize devices into folders and create multiple views</li> </ul> <p>Enter notes about a folder or device</p>	
Bootloader	<p><i>Bootloader</i>, the operating system that runs on the DeviceMaster UP hardware during the power on phase, which then starts the default application (either Modbus Router or SocketServer).</p> <p>SocketServer is the default application on DeviceMaster UPs ordered without a protocol loaded.</p>	





<b>EtherNet/IP Firmware and Documentation</b>		<b>Link</b>
Firmware	<p><b>EtherNet/IP (.msi)</b> file contains the firmware and supporting files. The firmware provides embedded configuration web pages. You may need to update the DeviceMaster UP with the latest version.</p> <p><i><b>Note:</b> If you are currently running EtherNet/IP firmware V2.x platform, you may want refer to the EtherNet/IP User Guide for architecture information before upgrading.</i></p> <p>Depending on the model you purchased, the DeviceMaster UP may or may not have the EtherNet/IP firmware loaded.</p> <p><i><b>Note:</b> Models that have a protocol loaded on the DeviceMaster UP are identified in PortVision DX and the DeviceMaster UP is labeled accordingly.</i></p>	
Documentation	<ul style="list-style-type: none"> <li>• <i>DeviceMaster UP Hardware Installation and Configuration Guide</i> (this guide) contains hardware installation, PortVision DX installation, and firmware updating procedures.</li> <li>• <i>EtherNet/IP Interface Configuration Quick Start</i> contains configuration procedures for the DeviceMaster UP embedded web pages.</li> <li>• <i>EtherNet/IP User Guide</i> contains detailed protocol-specific information about the DeviceMaster UP.</li> <li>• <i>DeviceMaster UP Filtering and Data Extraction Reference Guide</i> describes the data extraction and filtering processes provided by the DeviceMaster UP with EtherNet/IP.</li> </ul>	

<b>Modbus Router Firmware and Documentation</b>		<b>Link</b>
Firmware	<p><b>Modbus Router (.msi)</b> contains the firmware and supporting files. The firmware provides embedded configuration web pages. You may need to update the DeviceMaster UP with the latest version.</p> <p>Depending on the model you purchased, the DeviceMaster UP may or may not have the Modbus Router firmware loaded.</p> <p><i><b>Note:</b> Models that have a protocol loaded on the DeviceMaster UP are identified in PortVision DX and the DeviceMaster UP is labeled accordingly.</i></p>	
Documentation	<ul style="list-style-type: none"> <li>• <i>DeviceMaster UP 16-Port Hardware Installation and Configuration Guide</i> (this guide) contains hardware installation, PortVision DX installation, and firmware updating procedures.</li> <li>• <i>Modbus Router User Guide</i> contains detailed protocol-specific information about the DeviceMaster UP and configuration procedures.</li> </ul>	

Modbus Server Firmware and Documentation		Link
Firmware	<p><b>Modbus Server (.msi)</b> contains the firmware and supporting files. The firmware provides embedded configuration web pages. You may need to update the DeviceMaster UP with the latest version.</p> <p>Depending on the model you purchased, the DeviceMaster UP may or may not have the Modbus/TIP firmware loaded.</p> <p><b>Note:</b> <i>Models that have a protocol loaded on the DeviceMaster UP are identified in PortVision DX and the DeviceMaster UP is labeled accordingly.</i></p>	
Documentation	<ul style="list-style-type: none"> <li>• <i>DeviceMaster UP Hardware Installation and Configuration Guide</i> (this guide) contains hardware installation, PortVision DX installation, and firmware updating procedures.</li> <li>• <i>Modbus Server User Guide</i> contains detailed protocol-specific information about the DeviceMaster UP.</li> </ul>	

Modbus/TCP Firmware and Documentation		Link
Firmware	<p><b>Modbus/TCP (.msi)</b> contains the firmware and supporting files. The firmware provides embedded configuration web pages. You may need to update the DeviceMaster UP with the latest version.</p> <p><b>Note:</b> <i>If you are currently running Modbus/TCP firmware V2.x platform, you may want refer to the DeviceMaster UP Modbus/TCP User Guide for architecture information before upgrading.</i></p> <p>Depending on the model you purchased, the DeviceMaster UP may or may not have the Modbus/TCP firmware loaded.</p> <p><b>Note:</b> <i>Models that have a protocol loaded on the DeviceMaster UP are identified in PortVision DX and the DeviceMaster UP is labeled accordingly.</i></p>	
Documentation	<ul style="list-style-type: none"> <li>• <i>DeviceMaster UP Hardware Installation and Configuration Guide</i> (this guide) contains hardware installation, PortVision DX installation, and firmware updating procedures.</li> <li>• <i>Modbus/TCP Interface Configuration Quick Start</i> contains an installation overview and configuration procedures for DeviceMaster UP embedded web pages.</li> <li>• <i>Modbus/TCP User Guide</i> contains detailed protocol-specific information about the DeviceMaster UP.</li> <li>• <i>DeviceMaster UP Filtering and Data Extraction Reference Guide</i> describes the data extraction and filtering processes provided by the DeviceMaster UP with Modbus/TCP 3.x firmware or higher.</li> </ul>	

<b>PROFINET IO Firmware and Documentation</b>		<b>Link</b>
Firmware	<p><b>PROFINET IO (.msi)</b> contains the firmware and supporting files. The firmware provides embedded configuration web pages. You may need to update the DeviceMaster UP with the latest version.</p> <p>Depending on the model you purchased, the DeviceMaster UP may or may not have the PROFINET IO firmware loaded.</p> <p><b>Note:</b> <i>Models that have a protocol loaded on the DeviceMaster UP are identified in PortVision DX and the DeviceMaster UP is labeled accordingly.</i></p>	
Documentation	<ul style="list-style-type: none"> <li>• <i>DeviceMaster UP Hardware Installation Guide</i> (this guide) contains hardware installation, PortVision DX installation, and firmware updating procedures.</li> <li>• <i>PROFINET IO Quick Start</i> is an outline of the installation and configuration procedures with links to the appropriate documents.</li> <li>• <i>DeviceMaster UP Filtering and Data Extraction Reference Guide</i> describes the data extraction and filtering processes provided by the DeviceMaster UP with PROFINET IO.</li> </ul>	



# Hardware Installation

## Installation Overview

Use the links below to locate installation procedures for the following models:

Ports	DeviceMaster UP	Installation Procedure
1†	DB9 serial port with a single Ethernet port	<a href="#">1-Port - Panel Mount Installation</a> on Page 14
1-Port	Screw terminal serial port - DIN rail	<a href="#">1-Port DIN Rail (Terminal Block) Installation</a> on Page 16
1-Port	DB9 serial port - DIN rail	<a href="#">1-Port DIN Rail (DB9) Installation</a> on Page 17
2††	Screw terminal serial ports	<a href="#">2-Port (Terminal Block) 1E/2E Installation</a> on Page 19
2‡	DB9 serial ports	<a href="#">2-Port (DB9) 1E/2E Installation</a> on Page 21
4†	DB9 serial ports DIN rail model with dual Ethernet†† ports	<a href="#">4-Port DIN Rail Models Installation</a> on Page 23
4†	DB9 serial ports with dual Ethernet†† ports	<a href="#">4-Port Installation</a> on Page 25
† The DeviceMaster UP 4 -port models also include DB9 to RJ45 adapters.		
†† One of the Ethernet ports on the DeviceMaster UP is a built-in downstream port for daisy-chaining DeviceMaster UP systems or other network-ready devices.		

**Note:** If you have a DeviceMaster UP with 16-ports, use the [DeviceMaster UP 16-Port Hardware User Guide](#) because the RJ45 connectors have different pin outs.

### Default Network Settings

IP address:  
192.168.250.250

Subnet mask:  
255.255.0.0

Gateway address:  
192.168.250.1

## 1-Port - Panel Mount Installation

Use the following procedure to install the DeviceMaster UP 1-Port (panel mount).

1. Place the 1-Port on a stable surface and skip to [Step 2](#) or optionally mount the DeviceMaster UP using the mounting flanges or DIN rail adapters.
  - a. Pick up the DeviceMaster UP so that the front of the device is facing you.
  - b. Pick up a DIN rail clip. (The three tines should be on top and the M4 label should face you.)
  - c. Slide the DIN rail clip behind the DeviceMaster UP and line it up with one of the screw holes on the DeviceMaster UP.
  - d. Insert the M4 screw into the hole and tighten with a Phillips screwdriver.
  - e. Repeat [Steps b](#) through d with the second DIN rail clip. Make sure the screws on both DIN rail clips line up.

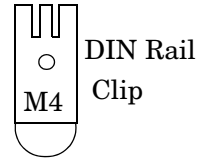

**Note:** If you need to remove the DeviceMaster UP from the DIN rail, exert pressure on the backside of the tabs at the bottom of both DIN rail clips.

- f. Attach the DeviceMaster UP to the DIN rail.

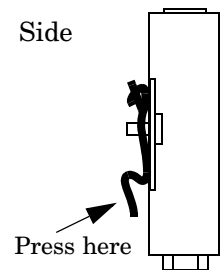
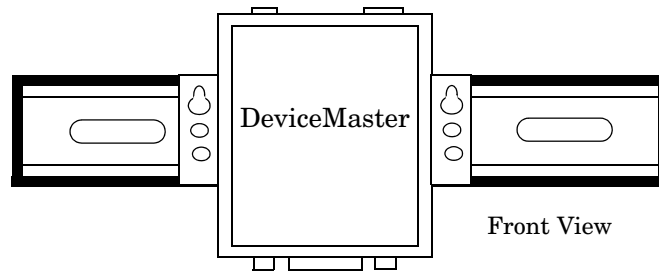

**Note:** Do not connect multiple units until you have changed the default IP address, see [Configuring the DeviceMaster UP](#) on Page 27

2. Connect the DeviceMaster UP port labeled **10/100 ETHERNET** to the same Ethernet network segment as the PLC using a standard network cable.
3. Apply power to the DeviceMaster UP using the following procedure.

**Note:** See [1-Port Panel Mount 5-30VDC Power Supply](#) on Page 78, if you want to provide your own power supply.



**Observe proper ESD techniques when connecting and disconnecting the DeviceMaster UP.**

- Insert the earth ground wire into the earth ground screw terminal.
- Insert the DC positive wire into the positive screw terminal and the DC return wire into the return screw terminal.

Refer to [1-Port Panel Mount 5-30VDC Power Supply](#) on Page 78 for detailed power requirements.

- Use a small flat head screw to lock the wires into place.
- Verify that each wire has been tightened securely.

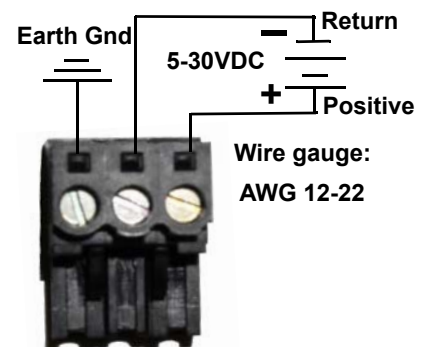

- Plug the screw terminal power connector into the DeviceMaster UP.
- **Note:** *Align the plug properly. The scalloped side of the screw terminal power connector should be aligned with the scalloped side of the power jack on the unit.*
- Connect the power supply to a power source.
- Go to [Step 4](#) to verify that the DeviceMaster UP is functioning properly.



4. Verify that the **Status** LED has completed the boot cycle and network connection for the DeviceMaster UP is functioning properly using the table below.

<b>1-Port Enclosed LED Descriptions</b>	
<b>Status</b>	<p>The amber <b>Status</b> LED on the device is lit, indicating you have power and it has completed the boot cycle.</p> <p><b>Note:</b> <i>The Status LED flashes while booting and it takes approximately 15 seconds for the Bootloader to complete the cycle. When the Bootloader completes the cycle, the LED has a solid, steady light that blinks approximately every 10 seconds.</i></p>
<b>Link/Act</b>	<p>If the red <b>Link/Act</b> LED is lit, it indicates a working Ethernet connection.</p>
<b>Duplex</b>	<p>If the red <b>Duplex</b> LED is lit, it indicates full-duplex activity.</p>
<b>100</b>	<p>If the red <b>100</b> LED is lit, it indicates a working 100 MB Ethernet connection (100 MB network, only). If the LED is not lit, it indicates a 10 MB Ethernet connection.</p>
<p><b>Note:</b> <i>For additional LED information, go to the <a href="#">Status LED table</a> on Page 86.</i></p>	

5. Go to [Configuring the DeviceMaster UP](#) on Page 27 to install PortVision DX, configure the network settings, and if necessary, upload the appropriate protocol firmware on the DeviceMaster UP.

## 1-Port DIN Rail (Terminal Block) Installation

Use the following procedure to install DeviceMaster UP 1-port models with a serial screw terminal connector. See [1-Port DIN Rail \(DB9\) Installation](#) on Page 17 if the DeviceMaster UP has DB9 serial connectors.

1. Attach the DeviceMaster UP 1-Port to the DIN rail adapter.
2. Connect the power supply and apply power to the DeviceMaster UP using the power supply specifications on the product label and the following information.



Caution

**Observe proper ESD techniques when connecting and disconnecting the DeviceMaster UP.**

- a. Insert the earth ground wire into the chassis ground screw terminal. The chassis ground connection is made only if the DIN rail is NOT connected to signal ground.
- b. Insert the DC positive wire into the + screw terminal and the DC return wire into the - screw terminal.

Refer to [2-Port \(Serial Terminals\) Power Supply](#) on Page 79 for detailed power requirements.

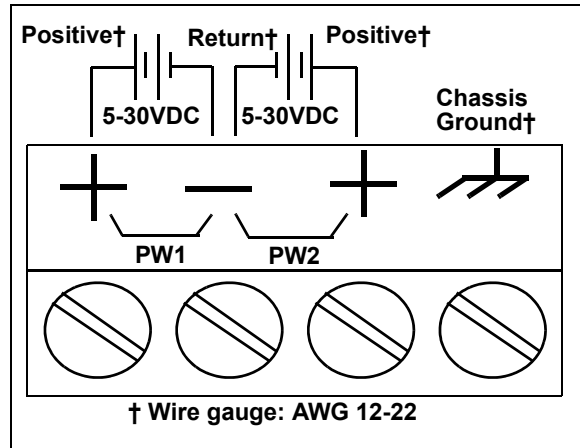

- c. Use a small flat head screw driver to lock the wires into place.
- d. Verify that each wire has been tightened securely.
- e. Connect a UL Listed power supply and UL Listed power cord to a power source to apply power.

**Note:** Do not connect multiple units until you have changed the default IP address, see [Configuring the DeviceMaster UP](#) on Page 27

3. Connect the **10/100 port** to the same Ethernet network segment as the host PC using a standard network cable.
4. Verify that the **Status LED** has completed the boot cycle and network connection for the DeviceMaster UP is functioning properly using the following table.

1-Port DIN Rail with Serial Terminal Connectors LED Descriptions	
<b>STATUS</b>	The <b>STATUS LED</b> on the device is lit, indicating you have power and it has completed the boot cycle. <b>Note:</b> The <b>STATUS LED</b> flashes while booting and it takes approximately 15 seconds for the Bootloader to complete the cycle. When the Bootloader completes the cycle, the LED has a solid, steady light that blinks approximately every 10 seconds.
<b>LINK</b>	If the <b>LINK</b> (green) LED is lit, it indicates a working Ethernet connection.
<b>ACT</b>	If the <b>ACT</b> (yellow) LED flashes, it indicates network activity.
<b>Note:</b> For additional LED information, go to the <a href="#">Status LED table</a> on Page 86.	



5. Go to [Configuring the DeviceMaster UP](#) on Page 27 for default network settings and how to configure the DeviceMaster UP for use.

## 1-Port DIN Rail (DB9) Installation

Use the following procedure to install a DeviceMaster UP 1-port model with a DB9 connector.

1. Attach the DeviceMaster UP 1-Port to the DIN rail adapter.
2. Connect the power supply and apply power to the DeviceMaster using the power supply specifications on the product label and the following information.



Caution

**Observe proper ESD techniques when connecting and disconnecting the DeviceMaster UP.**

- a. Insert the earth ground wire into the chassis ground screw terminal.

**Note:** *The chassis ground connection is made only if the DIN rail is NOT connected to earth ground.*

- b. Insert the DC positive wire into one of the + screw terminals and the DC return wire into the - screw terminal.
  - A second redundant power supply can be connected to the unit by inserting the DC positive wire into the other + screw terminal and the DC return wire into the - screw terminal.
  - The DeviceMaster UP will continue to operate if one of the two connected power supplies should fail.

Refer to [2-Port \(Serial Terminals\) Power Supply](#) on Page 79 for detailed power requirements.

- c. Use a small flat head screw driver to lock the wires into place.
- d. Verify that each wire has been tightened securely.
- e. Connect a UL Listed power supply and UL Listed power cord to a power source to apply power.

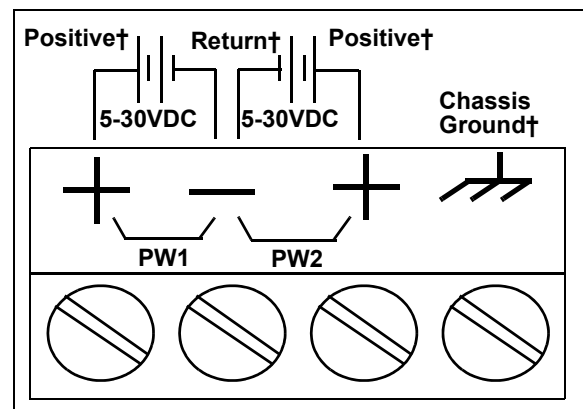

† Wire gauge: AWG 12-22

**Note:** *Do not connect multiple units until you have changed the default IP address, see [Configuring the DeviceMaster UP](#) on Page 27*

3. Connect a **10/100** port to the same Ethernet network segment as the host PC using a standard Ethernet cable.

- Verify that the **Status** LED has completed the boot cycle and network connection for the DeviceMaster UP is functioning properly using the following table.

<b>1-Port DIN Rail with DB9 Connectors LED Descriptions</b>	
<b>STATUS</b>	The <b>STATUS</b> LED on the device is lit, indicating you have power and it has completed the boot cycle. <i><b>Note:</b> The <b>STATUS</b> LED flashes while booting and it takes approximately 15 seconds for the Bootloader to complete the cycle. When the Bootloader completes the cycle, the LED has a solid, steady light that blinks approximately every 10 seconds.</i>
<b>LINK</b>	If the <b>LINK</b> (green) LED is lit, it indicates a working Ethernet connection.
<b>ACT</b>	If the <b>ACT</b> (yellow) LED flashes, it indicates network activity.
<i><b>Note:</b> For additional LED information, go to the <a href="#">Status LED table</a> on Page 86.</i>	

- Go to [Configuring the DeviceMaster UP](#) on Page 27 for default network settings and how to configure the DeviceMaster UP for use.

## 2-Port (Terminal Block) 1E/2E Installation

Use the following procedure to install DeviceMaster UP 2-port models with serial screw terminal connectors. See [2-Port \(DB9\) 1E/2E Installation](#) on Page 21 if the DeviceMaster UP has DB9 serial connectors.

1. Attach the DeviceMaster UP 2-Port to the DIN rail adapter.
2. Connect the power supply and apply power to the DeviceMaster using the power supply specifications on the product label and the following information.



Caution

**Observe proper ESD techniques when connecting and disconnecting the DeviceMaster UP.**

- a. Insert the earth ground wire into the chassis ground screw terminal if the DIN rail is NOT connected to earth ground.

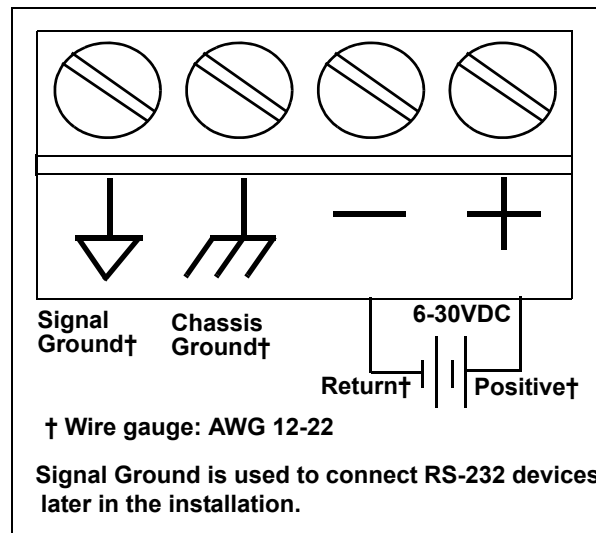

- b. Insert the DC positive wire into the + screw terminal and the DC return wire into the - screw terminal.

Refer to [2-Port \(DB9\) Power Supply](#) on Page 80 for detailed power requirements.

- c. Use a small flat head screw driver to lock the wires into place.
- d. Verify that each wire has been tightened securely.
- e. Connect a UL Listed power supply and UL Listed power cord to a power source to apply power.

**Note:** Do not connect multiple units until you have changed the default IP address, see [Configuring the DeviceMaster UP](#) on Page 27

3. Use the appropriate method for network attachment of your DeviceMaster UP 2-port.
  - DeviceMaster UP **1E**: Connect the **10/100 port** to the same Ethernet network segment as the host PC using a standard network cable.
  - DeviceMaster UP **2E**: Connect the DeviceMaster UP 2E using one of these methods:
    - **Ethernet hub, switch (10/100Base-T), or Server NIC (10/100Base-T)**: Connect a 10/100 port to the same Ethernet network segment as the host PC using a standard Ethernet cable.
    - **Daisy-chaining DeviceMaster UP units**: Connect the port labeled **E1** (or **E2**) on the first DeviceMaster UP to the port labeled **E1** (or **E2**) on the second DeviceMaster UP or other device using a standard Ethernet

cable. Refer to [Daisy-Chaining DeviceMaster UP 2E/4-Port Units](#) on Page 88 for more detailed information.

- Verify that the **Status** LED has completed the boot cycle and network connection for the DeviceMaster UP is functioning properly using the following table.

<b>2-Port with Serial Terminal Connectors LED Descriptions</b>	
<b>STATUS</b>	The <b>STATUS</b> LED on the device is lit, indicating you have power and it has completed the boot cycle. <i><b>Note:</b> The <b>STATUS LED</b> flashes while booting and it takes approximately 15 seconds for the Bootloader to complete the cycle. When the Bootloader completes the cycle, the LED has a solid, steady light that blinks approximately every 10 seconds.</i>
<b>LINK</b>	If the <b>LINK</b> (green) LED is lit, it indicates a working Ethernet connection.
<b>ACT</b>	If the <b>ACT</b> (yellow) LED flashes, it indicates network activity.
<i><b>Note:</b> For additional LED information, go to the <a href="#">Status LED table</a> on Page 86.</i>	

- Go to [Configuring the DeviceMaster UP](#) on Page 27 for default network settings and how to configure the DeviceMaster UP for use.

## 2-Port (DB9) 1E/2E Installation

Use the following procedure to install DeviceMaster UP 2-port models with DB9 connectors.

1. Attach the DeviceMaster UP 2-Port to the DIN rail adapter.
2. Connect the power supply and apply power to the DeviceMaster using the power supply specifications on the product label and the following information.



Caution

**Observe proper ESD techniques when connecting and disconnecting the DeviceMaster UP.**

- a. Insert the earth ground wire into the chassis ground screw terminal.

**Note:** The chassis ground connection is made only if the DIN rail is NOT connected to earth ground.

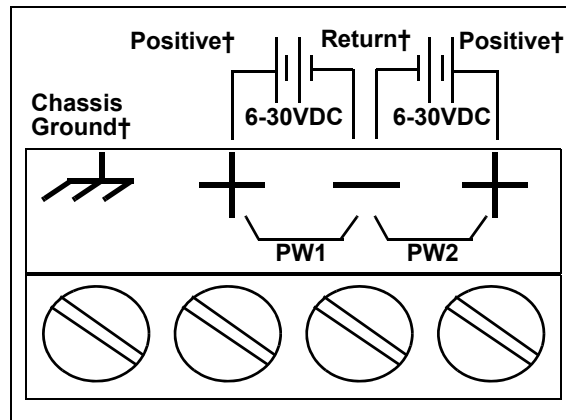

† Wire gauge: AWG 12-22

- b. Insert the DC positive wire into one of the + screw terminals and the DC return wire into the - screw terminal.

Refer to [2-Port \(DB9\) Power Supply](#) on Page 80 for detailed power requirements.

- c. Use a small flat head screw driver to lock the wires into place.
- d. Verify that each wire has been tightened securely.
- e. Connect a UL Listed power supply and UL Listed power cord to a power source to apply power.

**Note:** Do not connect multiple units until you have changed the default IP address, see [Configuring the DeviceMaster UP](#) on Page 27

3. Use the appropriate method for network attachment of your DeviceMaster UP 2-port:

- **DeviceMaster UP 1E:** Connect the **10/100 port** to the same Ethernet network segment as the host PC using a standard network cable.
- **DeviceMaster UP 2E:** Connect the DeviceMaster UP 2E using one of these methods:
  - **Ethernet hub, switch (10/100Base-T), or Server NIC (10/100Base-T):** Connect a **10/100 port** to the same Ethernet network segment as the host PC using a standard Ethernet cable.
  - **Daisy-chaining DeviceMaster UP units:** Connect the port labeled **E1** (or **E2**) on the first DeviceMaster UP to the port labeled **E1** (or **E2**) on the second DeviceMaster UP or other device using a standard Ethernet cable. Refer to [Daisy-Chaining DeviceMaster UP 2E/4-Port Units](#) on

Page 88 for more detailed information.

- Verify that the **Status LED** has completed the boot cycle and network connection for the DeviceMaster UP is functioning properly using the following table.

<b>2-Port with DB9 Connectors LED Descriptions</b>	
<b>STATUS</b>	The <b>STATUS LED</b> on the device is lit, indicating you have power and it has completed the boot cycle. <i>Note: The STATUS LED flashes while booting and it takes approximately 15 seconds for the Bootloader to complete the cycle. When the Bootloader completes the cycle, the LED has a solid, steady light that blinks approximately every 10 seconds.</i>
<b>LINK</b>	If the <b>LINK</b> (green) LED is lit, it indicates a working Ethernet connection.
<b>ACT</b>	If the <b>ACT</b> (yellow) LED flashes, it indicates network activity.
<i>Note: For additional LED information, go to the <a href="#">Status LED table</a> on Page 86.</i>	

- Go to [Configuring the DeviceMaster UP](#) on Page 27 for default network settings and how to configure the DeviceMaster UP for use.

## 4-Port DIN Rail Models Installation

Use the following procedure to install DeviceMaster UP 4-port DIN rail models.

1. Attach the DeviceMaster UP 4-Port to the DIN rail adapter.
2. Connect the power supply and apply power to the DeviceMaster using the power supply specifications on the product label and the following information.



**Observe proper ESD techniques when connecting and disconnecting the DeviceMaster UP.**

- a. Insert the earth ground wire into the chassis ground screw terminal.
 

**Note:** *The chassis ground connection is made only if the DIN rail is NOT connected to earth ground.*
- b. Insert the DC positive wire into one of the + screw terminals and the DC return wire into the - screw terminal.
  - A second redundant power supply can be connected to the unit by inserting the DC positive wire into the other + screw terminal and the DC return wire into the - screw terminal.
  - The DeviceMaster UP will continue to operate if one of the two connected power supplies should fail.

Refer to [4-Port DIN Rail Models Power Supply](#) on Page 80 for detailed power requirements.

- c. Use a small flat head screw driver to lock the wires into place.
- d. Verify that each wire has been tightened securely.
- e. Connect a UL Listed power supply and UL Listed power cord to a power source to apply power.

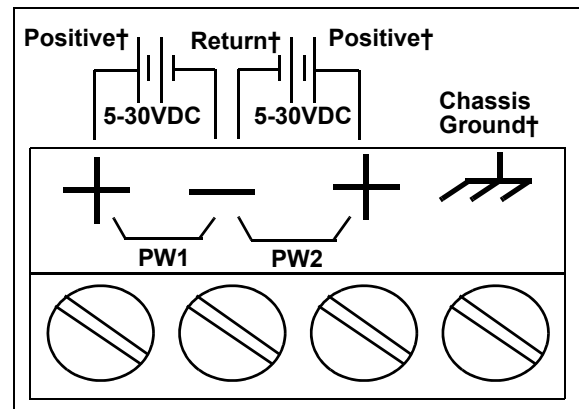

**Note:** *Do not connect multiple units until you have changed the default IP address, see [Configuring the DeviceMaster UP](#) on Page 27*

3. Use the appropriate method for network attachment of your DeviceMaster UP:
  - **Ethernet hub, switch (10/100Base-T), Server NIC (10/100Base-T):** Connect a 10/100 port to the same Ethernet network segment as the host PC using a standard Ethernet cable.
  - **Daisy-chaining DeviceMaster UP units:** Connect the port labeled E1 (or E2) on the first DeviceMaster UP to the port labeled E1 (or E2) on the second DeviceMaster UP or other device using a standard Ethernet cable. Refer to [Daisy-Chaining DeviceMaster UP 2E/4-Port Units](#) on Page 88 for more detailed information.

- Verify that the **Status** LED has completed the boot cycle and network connection for the DeviceMaster UP is functioning properly using the following table.

<b>4-Port DIN Rail with DB9 Connectors LED Descriptions</b>	
<b>STATUS</b>	The <b>STATUS</b> LED on the device is lit, indicating you have power and it has completed the boot cycle. <i><b>Note:</b> The <b>STATUS</b> LED flashes while booting and it takes approximately 15 seconds for the Bootloader to complete the cycle. When the Bootloader completes the cycle, the LED has a solid, steady light that blinks approximately every 10 seconds.</i>
<b>LINK</b>	If the <b>LINK</b> (green) LED is lit, it indicates a working Ethernet connection.
<b>ACT</b>	If the <b>ACT</b> (yellow) LED flashes, it indicates network activity.
<i><b>Note:</b> For additional LED information, go to the <a href="#">Status LED table</a> on Page 86.</i>	

- Go to [Configuring the DeviceMaster UP](#) on Page 27 for default network settings and how to configure the DeviceMaster UP for use.



## 4-Port Installation

Use the following procedure to install the DeviceMaster UP 4-port.

1. Optionally, attach the mounting brackets using the screws provided in the kit (6-32 1/4" flathead machine) or place the DeviceMaster UP on a stable surface.

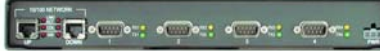

[Larger Picture, Page 84](#)



**Failure to use the correct screws can damage the PCB and void the warranty. Do NOT use screws that exceed the length of the screws provided with the mounting bracket kit.**

**Note:** If you ordered the DeviceMaster UP Rackmount Shelf Kit accessory, use the document that accompanied that kit or [download the document](#) to mount the DeviceMaster UP on the shelf.

**Note:** Do not connect multiple units until you have changed the default IP address, see [Initial Configuration](#) on Page 37.

2. Connect the DeviceMaster UP to the same Ethernet network segment as the PLC using one of the following methods:
  - **Ethernet hub or switch (10/100Base-T):** Connect to the port labeled **UP** on the DeviceMaster UP using a standard Ethernet cable.
  - **Server NIC (10/100Base-T):** Connect to the port labeled **DOWN** on the DeviceMaster UP using a standard Ethernet cable.
  - **Daisy-chaining DeviceMaster UP units:** Connect the port labeled **DOWN** on the first DeviceMaster UP to the port labeled **UP** on the second DeviceMaster UP or other device using a standard Ethernet cable. Refer to [Daisy-Chaining DeviceMaster UP 2E/4-Port Units](#) on Page 88.

**Note:** Do not connect multiple units until you have changed the default IP address, see [Configuring the DeviceMaster UP](#) on Page 27

3. Apply power to the DeviceMaster UP by connecting the AC power adapter to the DeviceMaster UP, the appropriate power cord for your location to the power adapter, and plugging the power cord into a power source. If you want to provide a power supply, see [4-Port Panel Mount Power Supply](#) on Page 81.
4. Verify that the **PWR** LED has completed the boot cycle and the network connection for the DeviceMaster UP is functioning properly.

4-Port LED Descriptions	
<b>PWR</b>	LED on the front panel of the DeviceMaster UP is lit, indicating you have power and it has completed the boot cycle. <b>Note:</b> The <b>PWR LED</b> flashes while booting and it takes approximately 15 seconds for the Bootloader to complete the cycle. When the Bootloader completes the cycle, the LED has a solid, steady light that blinks approximately every 10 seconds.
<b>LNK ACT</b>	The red <b>LNK ACT</b> LED is lit, indicating that you have a working Ethernet connection.
<b>COL</b>	If the red <b>COL</b> LED is lit, there is a network collision.
<b>100</b>	If the red <b>100</b> LED is lit, it indicates a working 100 MB Ethernet connection (100 MB network, only). If the LED is not lit, it indicates a 10 MB Ethernet connection.

**Note:** For additional LED information, go to the [Status LED table](#) on Page 86.

5. Go to [Configuring the DeviceMaster UP](#) on Page 27 to install PortVision DX, configure the network settings, and if necessary, upload the appropriate protocol firmware on the DeviceMaster UP.

---

---

## Adding a Unit to an Existing Installation

---

---

Use this procedure to add another DeviceMaster UP to an existing configuration.

1. Install the DeviceMaster UP to an Ethernet hub or server NIC using the appropriate subsection found in [Installation Overview](#) on Page 13.  
*Note: Technical support recommends installing one unit at a time and testing that unit when installing multiple units. In the event troubleshooting must be done, a single unit is easier to resolve than several at once.*
2. Power-up the new DeviceMaster UP and verify that the **PWR** or **Status LED** lights.
3. Program an IP address into the new DeviceMaster UP using PortVision DX.
4. If necessary, upload the latest firmware.
5. Configure serial ports to support the serial devices or upload configuration files from PortVision DX.
6. Connect the serial devices.

---

---

## Replacing Hardware

---

---

Use this procedure to replace hardware.

1. Configure the IP address in the new DeviceMaster UP.
2. Remove the old unit and attach a new or spare DeviceMaster UP.
3. Connect the new DeviceMaster UP to the network hub or server NIC.
4. Apply power to the new DeviceMaster UP and verify that it passes the power on self-test.
5. Program the IP address of the new DeviceMaster UP.
6. If necessary, upload the latest protocol firmware.
7. Configure any ports as necessary to match the previous unit or upload configuration files from PortVision DX.
8. Transfer *all* cabling from the old DeviceMaster UP to the new DeviceMaster UP.
9. *It is not necessary* to shut down and restart the host PC.

# Configuring the DeviceMaster UP

The DeviceMaster UP platform includes PortVision DX, which is the management application that you use to manage all Control Ethernet-attached devices.

**Note:** *Existing installations: PortVision DX replaces PortVision Plus, you must install PortVision DX v3.02 or higher to upload the latest firmware.*

This section contains these topics:

- [PortVision DX Overview](#)
- [PortVision DX Requirements](#) on Page 28
- [Installing PortVision DX](#) on Page 28
- [Configuring the Network Settings](#) on Page 32
- [Checking the Protocol Firmware Version](#) on Page 35
- [Uploading Protocol-Specific Firmware on the DeviceMaster UP](#) on Page 36
- [Customizing PortVision DX](#) on Page 38
- [Accessing DeviceMaster UP Documentation from PortVision DX](#) on Page 39

**Note:** *If PortVision DX is already installed, go directly to [Configuring the Network Settings](#) on Page 32 to change the IP address on the DeviceMaster UP.*

---

---

## PortVision DX Overview

PortVision DX automatically detects Control Ethernet-attached products physically attached to the local network segment so that you can configure the network address, upload firmware, and manage the following products:

- DeviceMaster family
  - DeviceMaster PRO
  - DeviceMaster RTS
  - DeviceMaster Serial Hub
  - DeviceMaster UP
  - DeviceMaster 500
- DeviceMaster LT
- IO-Link Master
- RocketLinx switches

In addition to identifying Control Ethernet-attached products, you can use PortVision DX to display any third-party switch and hardware that may be connected directly to those devices. All non-Control products and unmanaged RocketLinx switches are treated as non-intelligent devices and have limited feature support. For example, you cannot configure or update firmware on a third-party switch.

## PortVision DX Requirements

---

---

Use PortVision DX to identify, configure, update, and manage the DeviceMaster UP on the following Windows operating systems:

- Windows 10
- Windows 8/8.1
- Windows Server 2012
- Windows 7
- Windows Server 2008
- Windows Vista
- Windows Server 2003
- Windows XP SP3

PortVision DX requires that you connect the Comtrol Ethernet-attached product to the same network segment as the Windows host system if you want to be able to scan and locate it automatically during the configuration process.

Before installing PortVision DX, consider the following:

- Use PortVision DX to upload firmware and apply changes to a DeviceMaster UP that is on the same local network segment as the system on which PortVision DX is installed. You cannot apply changes through PortVision DX to a DeviceMaster UP that is not on the same local network segment.
- Use PortVision DX to monitor any DeviceMaster UP on the network. The DeviceMaster UP does not have to be on the same local network segment as PortVision DX for monitoring purposes.

## Installing PortVision DX

---

---

During initial configuration, PortVision DX automatically detects and identifies DeviceMaster UP units, if they are in the same network segment.

Use the *Software and Documentation* CD that came with the DeviceMaster UP to check for the latest version of PortVision DX or use the link below to download the latest version.

1. Download PortVision DX: [http://downloads.comtrol.com/dev\\_mstr/portvision\\_dx](http://downloads.comtrol.com/dev_mstr/portvision_dx).

**Note:** Depending on your operating system, you may need to respond to a Security Warning to permit access.

2. Execute the **PortVision\_DX[version].msi** file.

3. Click **Next** on the *Welcome* screen.



4. Click **I accept the terms in the License Agreement** and **Next**.

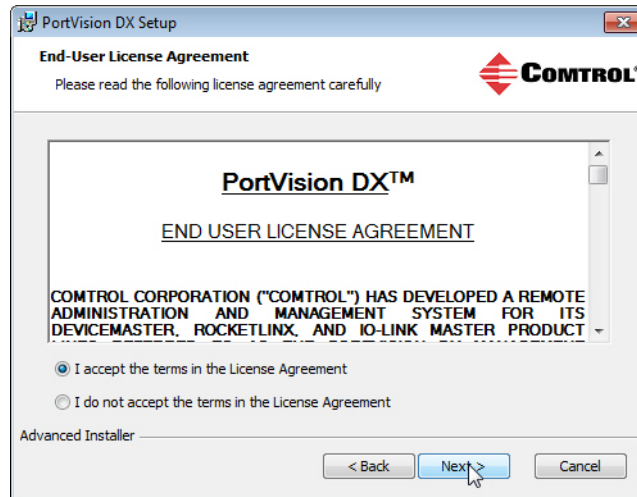

5. Click **Next** or optionally, browse to a different location and then click **Next**.

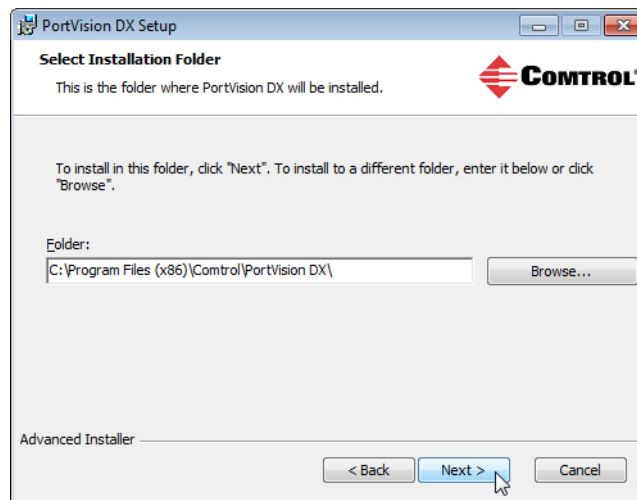

6. Click **Next** to configure the shortcuts.

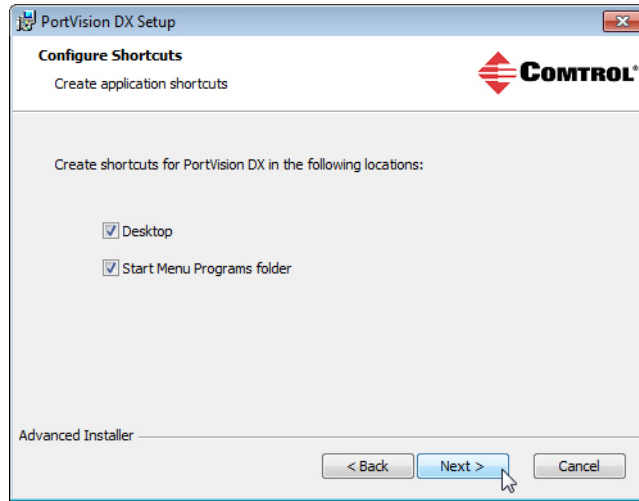

7. Click **Install**.

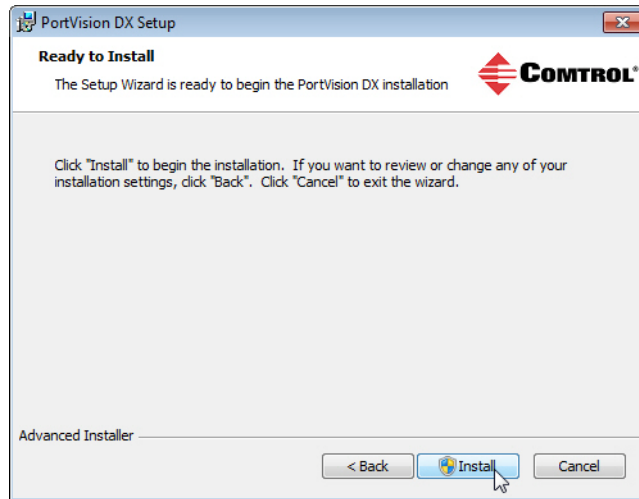

8. Depending on the operating system, you may need to click **Yes** to the *Do you want to allow the following program to install software on this computer?* query.

- Click **Launch PortVision DX** and **Finish** in the last installation screen.

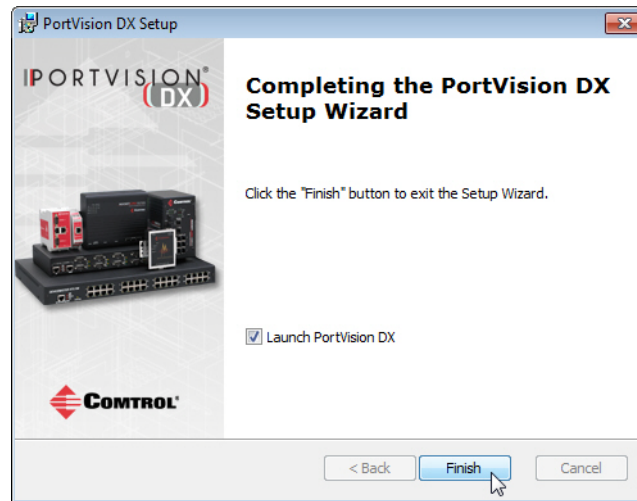

- Depending on the operating system, you may need to click **Yes** to the *Do you want to allow the following program to make changes to this computer?* query.
- Select the Control Ethernet-attached products that you want to locate and then click **Scan**.

*You can save time if you only scan for DeviceMaster*

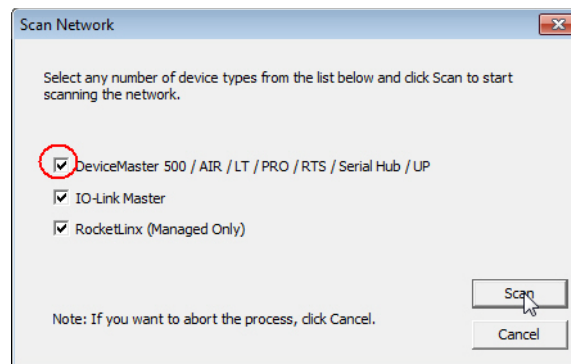

**Note:** *If the Control Ethernet-attached product is not on the local segment and it has been programmed with an IP address, it will be necessary to manually add the Control Ethernet-attached product to PortVision DX.*

- Go to [Step 5](#) in the next section, *Configuring the Network Settings*, to program the DeviceMaster UP network settings.

If you need additional information about PortVision DX, refer to the **Help** system.

## Configuring the Network Settings

Use the following procedure to change the default network settings on the DeviceMaster UP for your network.

### Default Network Settings

IP address:  
192.168.250.250

Subnet mask:  
255.255.0.0

Gateway address:  
192.168.250.1

**Note:** *Technical Support advises configuring one new DeviceMaster UP at a time to avoid device driver configuration problems. If you want to configure multiple DeviceMaster UPs using the **Assign IP to Multiple Devices** option, see [Configuring Multiple DeviceMaster UPs Network Addresses](#) on Page 57.*

The following procedure shows how to configure a single DeviceMaster UP connected to the same network segment as the Windows system. If the DeviceMaster UP is not on the same physical segment, you can add it manually using [Adding a New Device in PortVision DX](#) on Page 57.

1. If you have not done so, install PortVision DX ([Installing PortVision DX](#) on Page 28).
2. Start PortVision DX using the **PortVision DX** desktop shortcut or from the **Start** button, click **Programs > Control > PortVision DX > PortVision DX**.
3. Depending on your operating system, you may need to click **Yes** to the *Do you want to allow the following program to make changes to this computer?* query.
4. Click **Scan** to locate the Control Ethernet-attached products including the DeviceMaster UP on the network.

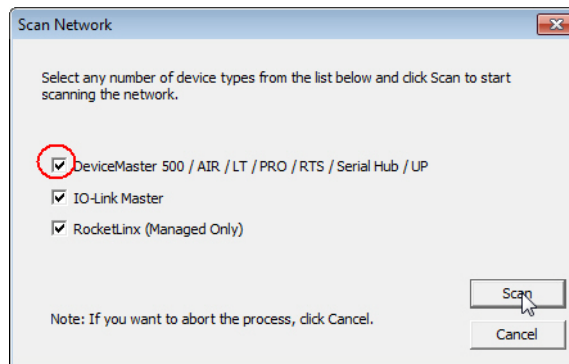

**Note:** *If you do not have any RocketLinx managed switches or IO-Link Masters, it saves scanning time if you do not scan for them.*



5. Highlight the DeviceMaster UP for which you want to program network information and open the **Properties** screen using one of these methods.
  - Double-click the DeviceMaster UP in the *Device Tree* or *Device List* pane.
  - Right-click the DeviceMaster UP in the *Device Tree* or *Device List* pane and click **Properties** in the popup menu
  - Highlight the DeviceMaster UP in the *Device Tree* or *Device List* pane and click the **Properties** button.
  - Highlight the DeviceMaster UP, click the **Manage** menu and then **Properties**.

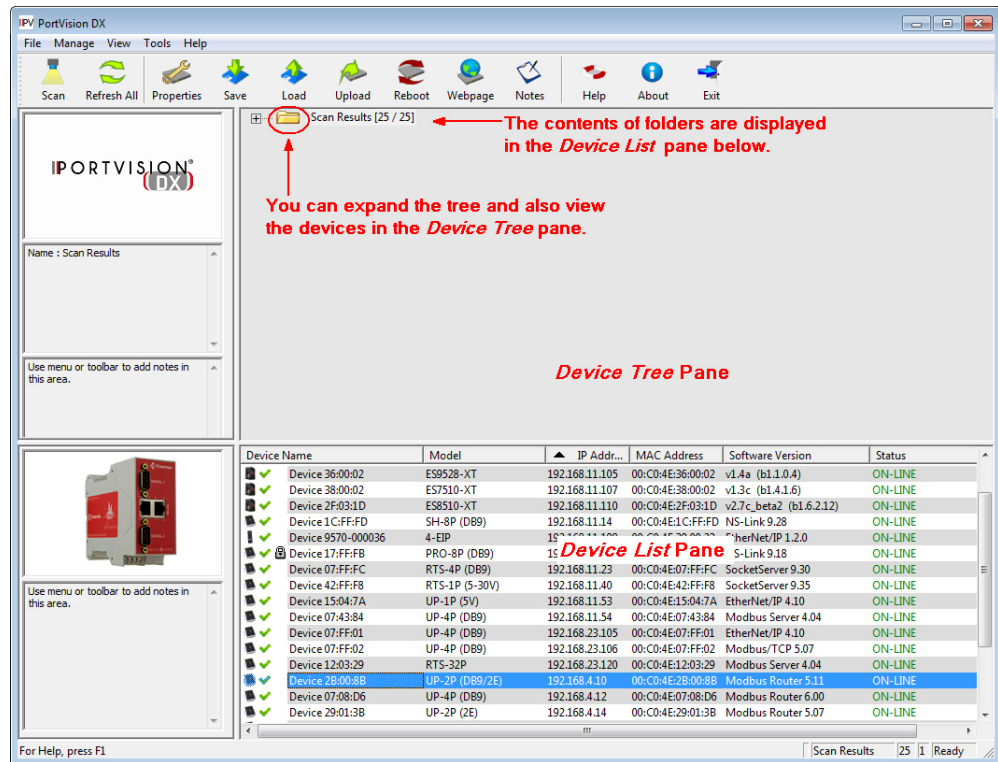

6. *Optionally*, rename the DeviceMaster UP in the **Device Name** field.

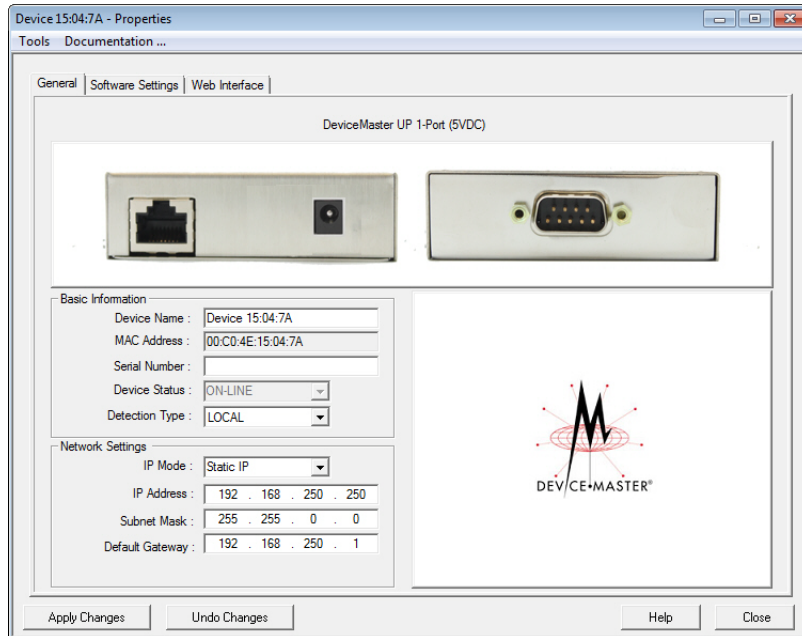

**Note:** The MAC address Device Status fields are automatically populated and you cannot change those values.

7. *Optionally*, enter the serial number, which is on a label on the DeviceMaster UP.
8. If necessary, you can change the **Detection Type**.
  - **REMOTE** means that the DeviceMaster UP is not connected to this segment of the network and it uses IP communications, not MAC communications.
  - **LOCAL** means that the DeviceMaster UP is on this local network segment and uses MAC communications. An IP address is not required but Technical support recommends using an IP address.
9. Change the DeviceMaster UP network properties as required for your site.

<b>Disable IP</b>	Do not use this option. The DeviceMaster UP does not support using the MAC addressing scheme.
<b>DHCP IP†</b>	Click this option if you want to use the DeviceMaster UP with DHCP. Make sure that you provide the MAC address of the DeviceMaster UP to the network administrator.
<b>Static IP†</b>	Click this option to program a static IP address and type the appropriate IP address, subnet mask, and default gateway values for your site in the provided boxes.
† <b>PROFINET IO:</b> The network address entered here must match the IP address entered in SIMATIC Step7. See the <a href="#">DeviceMaster UP PROFINET IO Installation Quick Start</a> for information about assigning addresses.	

**Note:** For additional information, open the PortVision DX Help system.

10. Click **Apply Changes** to update the network information on the DeviceMaster UP.

**Note:** If you are deploying multiple DeviceMaster UPs that share common values, you can save the configuration file and load that configuration onto other DeviceMaster UPs. See [Using Configuration Files](#) on Page 59 for more information.

11. Click **Close** to exit the *Properties* window.
12. If applicable, check your firmware version to make sure that it is the latest version using the next subsection, [Checking the Protocol Firmware Version](#).
13. If necessary, use [Uploading Protocol-Specific Firmware on the DeviceMaster UP](#) on Page 36 to update or load the firmware for your DeviceMaster UP.

## Checking the Protocol Firmware Version

Use PortVision DX to check the firmware version before configuring the ports.

Depending on the model you purchased, the DeviceMaster UP may or may not have the protocol firmware loaded.

**Note:** Models that have a protocol loaded on the DeviceMaster UP are identified in PortVision DX and the DeviceMaster UP is labeled accordingly.

The following procedure shows how to use PortVision DX to check the firmware version on the DeviceMaster UP and check for the latest files.

**Note:** If you have not done so, install PortVision DX ([Installing PortVision DX](#) on Page 28).

1. Start PortVision DX by double-clicking the PortVision DX desktop icon or click **Start > Programs > Control > PortVision DX > PortVision DX**.
2. Examine the *List View* pane to see if or/and what version of the firmware is loaded on the DeviceMaster UP. If you see SocketServer or NS-Link as the *Software Version*, you must load the appropriate firmware for your protocol.

The screenshot shows the PortVision DX application window. The main pane displays a tree view of scan results for 25 devices. Below this, a table lists the details for each device, including its name, model, IP address, MAC address, software version, and status. The software version column is highlighted in yellow.

Device Name	Model	IP Addr...	MAC Address	Software Version	Status
Device 36:00:02	ES9528-XT	192.168.11.105	00:C0:4E:36:00:02	v1.4a (b1.1.0.4)	ON-LINE
Device 38:00:02	ES7510-XT	192.168.11.107	00:C0:4E:38:00:02	v1.3c (b1.4.1.6)	ON-LINE
Device 2F:03:1D	ES8510-XT	192.168.11.110	00:C0:4E:2F:03:1D	v2.7c_beta2 (b1.6.2.12)	ON-LINE
Device 1 C:FF:FD	SH-8P (DB9)	192.168.11.114	00:C0:4E:1C:FF:FD	NS-Link 9.28	ON-LINE
Device 9570-000036	4-EIP	192.168.11.198	00:C0:4E:39:00:23	EtherNet/IP 1.2.0	ON-LINE
Device 17:FF:FB	PRO-8P (DB9)	192.168.11.20	00:C0:4E:17:FF:FB	NS-Link 9.18	ON-LINE
Device 07:FF:FC	RTS-4P (DB9)	192.168.11.23	00:C0:4E:07:FF:FC	SocketServer 9.30	ON-LINE
Device 42:FF:FB	RTS-1P (5-30V)	192.168.11.40	00:C0:4E:42:FF:FB	SocketServer 9.35	ON-LINE
Device 15:04:7A	UP-1P (5V)	192.168.11.53	00:C0:4E:15:04:7A	EtherNet/IP 4.10	ON-LINE
Device 07:43:84	UP-4P (DB9)	192.168.11.54	00:C0:4E:07:43:84	Modbus Server 4.04	ON-LINE
Device 07:FF:01	UP-4P (DB9)	192.168.23.105	00:C0:4E:07:FF:01	EtherNet/IP 4.10	ON-LINE
Device 07:FF:02	UP-4P (DB9)	192.168.23.106	00:C0:4E:07:FF:02	Modbus/TCP 5.07	ON-LINE
Device 12:03:29	RTS-32P	192.168.23.120	00:C0:4E:12:03:29	Modbus Server 4.04	ON-LINE
Device 28:00:8B	UP-2P (DB9/2E)	192.168.4.10	00:C0:4E:28:00:8B	Modbus Router 5.11	ON-LINE
Device 07:08:D6	UP-4P (DB9)	192.168.4.12	00:C0:4E:07:08:D6	Modbus Router 6.00	ON-LINE
Device 29:01:3B	UP-2P (2E)	192.168.4.14	00:C0:4E:29:01:3B	Modbus Router 5.07	ON-LINE

3. Check the Control FTP site to see if there is a later version available: [http://downloads.comtrol.com/html/up\\_main.htm](http://downloads.comtrol.com/html/up_main.htm).
4. If applicable, download the latest version and go to [Step 2](#) in [Uploading Protocol-Specific Firmware on the DeviceMaster UP](#) on Page 36.

## Uploading Protocol-Specific Firmware on the DeviceMaster UP

Some DeviceMaster UP models come from the factory with SocketServer firmware, which provides an interface to TCP/IP socket mode configuration and services, installed on the device.

If your DeviceMaster UP contains SocketServer and you want to configure one of the following environments, you must replace SocketServer with protocol-specific firmware:

- EtherNet/IP
- Modbus Router
- Modbus Server
- Modbus/TCP
- PROFINET IO

The CD shipped with the DeviceMaster UP contains the required firmware and support files in a self-installing (.msi) file or you can download the latest from the Internet.

Use the following procedure to update the firmware on your DeviceMaster UP for the appropriate protocol. See [Locating Software and Documentation](#) on Page 8, if you need to download the .msi file for your protocol.

**Note:** If you have not done so, install PortVision DX ([Installing PortVision DX](#) on Page 28) and install the firmware.msi file.

1. Start PortVision DX by double-clicking the PortVision DX desktop icon or click **Start > Programs > Control > PortVision DX > PortVision DX**.
2. Right-click the device or devices for which you want to upload firmware and click the **Advanced > Upload Firmware** menu option.

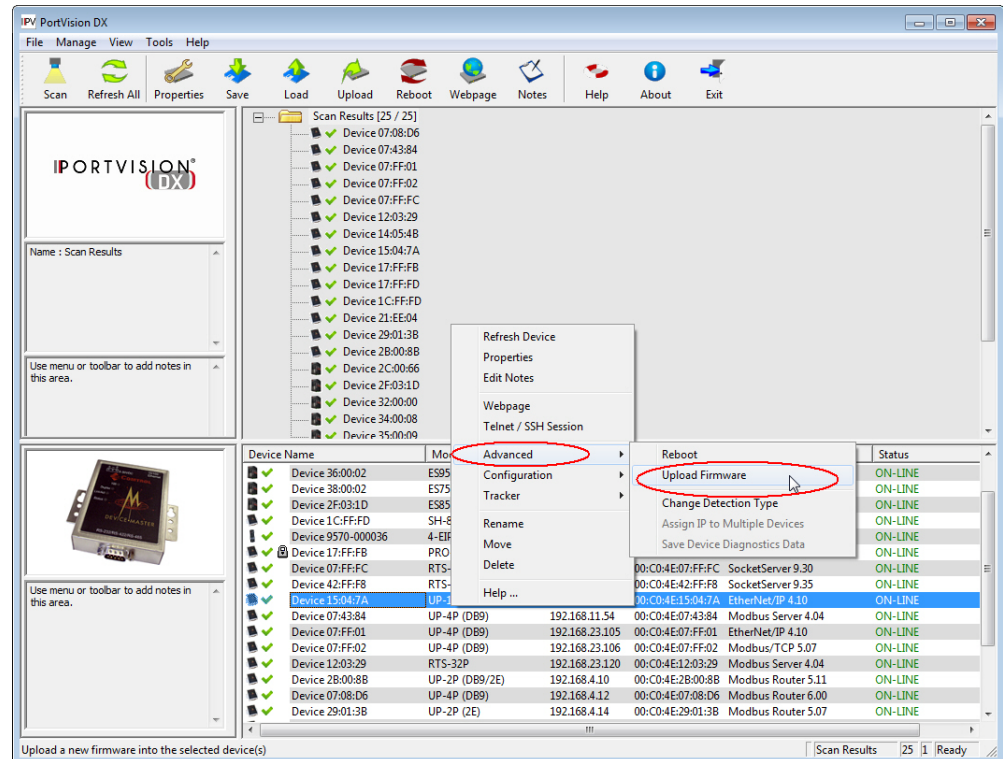

**Note:** Optionally, you can highlight a device and use the **Load** button.

3. Browse and select the protocol firmware (.cmtl) file and click **Open**.

4. Click **Yes** to upload the firmware.

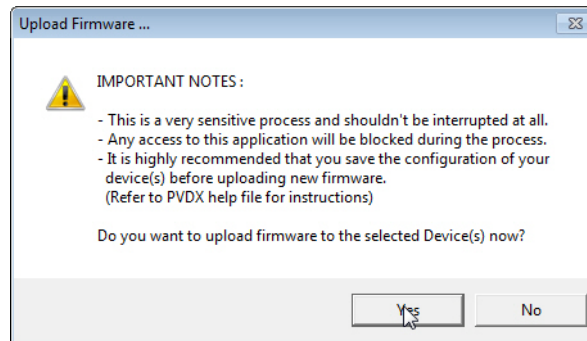

5. Click **OK** to the advisory message about waiting until the DeviceMaster UP is on-line and in the next minute the DeviceMaster UP unit or units should display **ON-LINE** in the **Status** field.

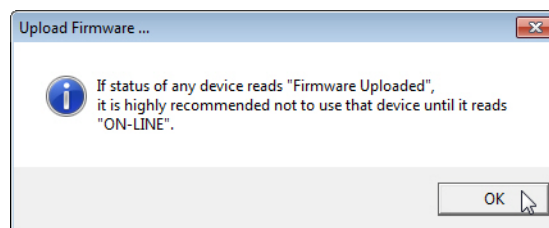

6. Go to the appropriate *Quick Start* or *User Guide* for your protocol for information about configuring the serial port or ports using the web page and programming your PLCs. See [Locating Software and Documentation](#) on Page 8 to locate the document for your protocol or refer to the installation CD shipped with the DeviceMaster UP.

If you are planning on installing multiple DeviceMaster UPs, you may want to use the *Save / Load Configuration File* feature in PortVision DX.

A configuration file can contain network settings and protocol settings. Refer to the PortVision DX help system for information about saving and loading configuration files.

7. After configuring the serial port characteristics and preparing your PLC programs, you can use the next section in this guide, to attach the serial device or devices.

## Customizing PortVision DX

You can customize how PortVision DX displays the devices. You can even create sessions tailored for specific audiences. You can also add shortcuts to other applications using **Tools > Applications > Customize** feature.

The following illustrates how you can customize your view.

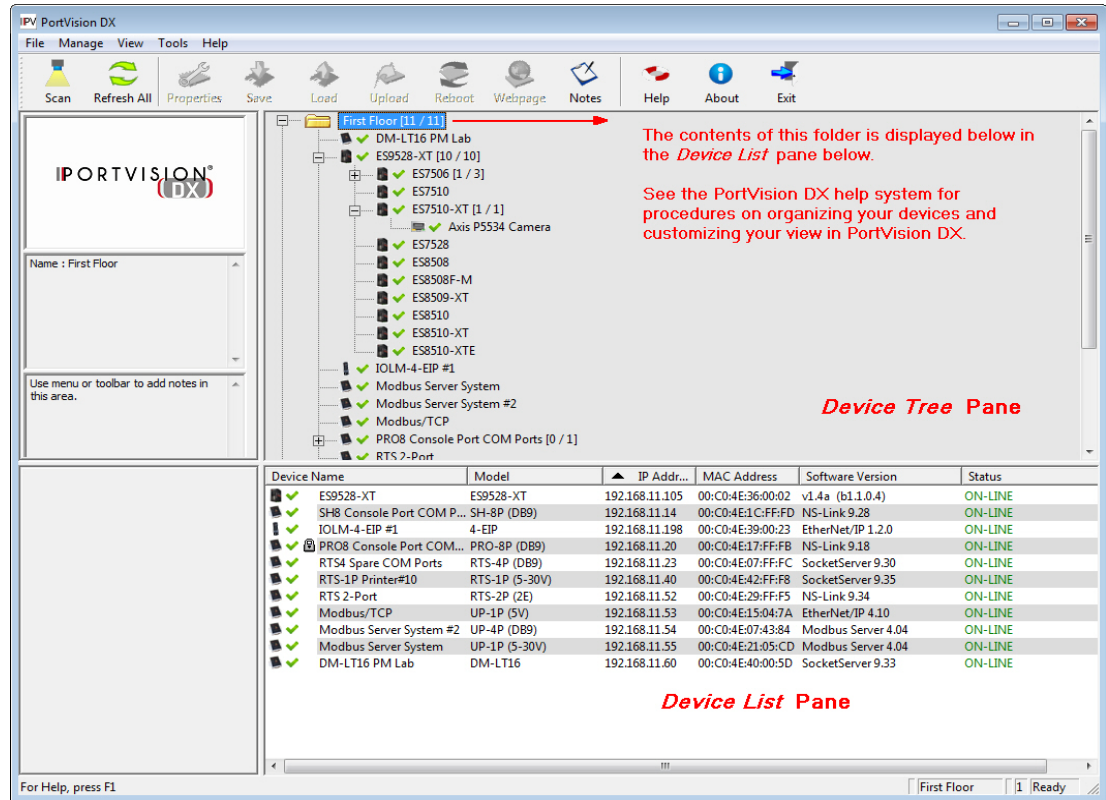

See the PortVision DX Help system for detailed information about modifying the view. For example, the above screen shot illustrates devices layered in folders.

## Accessing DeviceMaster UP Documentation from PortVision DX

You can use this procedure in PortVision DX to [download](#) and [open the previously downloaded documents](#) for the DeviceMaster UP. You can also check to see if you have the latest version of the documentation using PortVision DX.

### How to Download Documentation

Use this procedure to initially download a document or documents.

1. If necessary, open **PortVision DX > Start/Programs > Control > PortVision DX > PortVision DX** or use the desktop shortcut.
2. Click **Help > Documentation**.
3. Optionally, click the **DOWNLOAD THE CURRENT DOCUMENTATION CATALOG ONLINE** button to make sure that the latest documentation is available to PortVision DX.

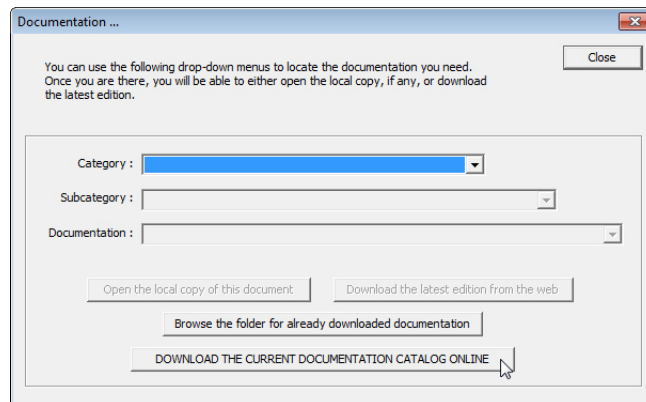
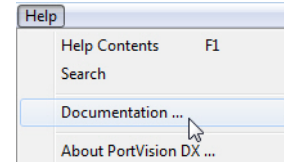

4. Select the product **Category** from the drop list.
5. Select the document you want to download from the **Documentation** drop list.
6. Click the **Download the latest edition from the web** button.

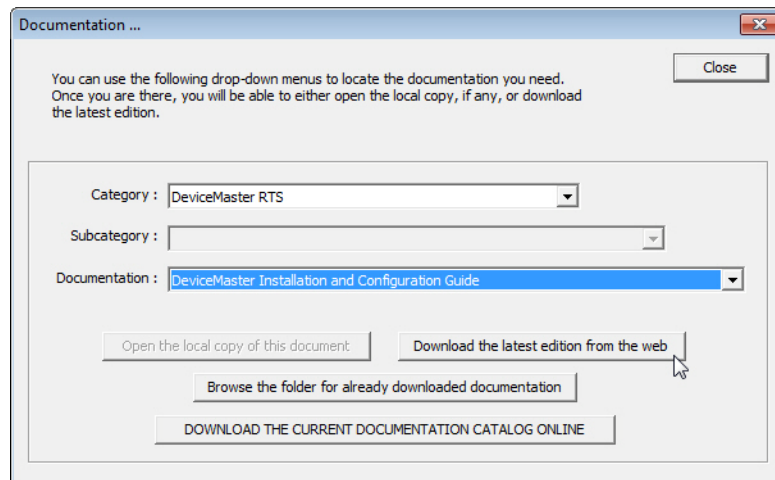

**Note:** It may take a few minutes to download, depending on your connection speed. The document opens automatically after it has downloaded.

7. Click **Close** if you have downloaded all of the documents that you wanted.

## How to Open Previously Downloaded Documents

Use the following procedure to access previously downloaded documents in PortVision DX.

**Note:** *Optionally, you can browse to the **Program Files (x86) > Control > PortVision DX > Docs** subdirectory and open the document.*

1. If necessary, open **PortVision DX > Start/Programs > Control > PortVision DX > PortVision DX** or use the desktop shortcut.
2. Click **Help > Documentation**.
3. Click the **Open the local copy of the document** button to view the document.

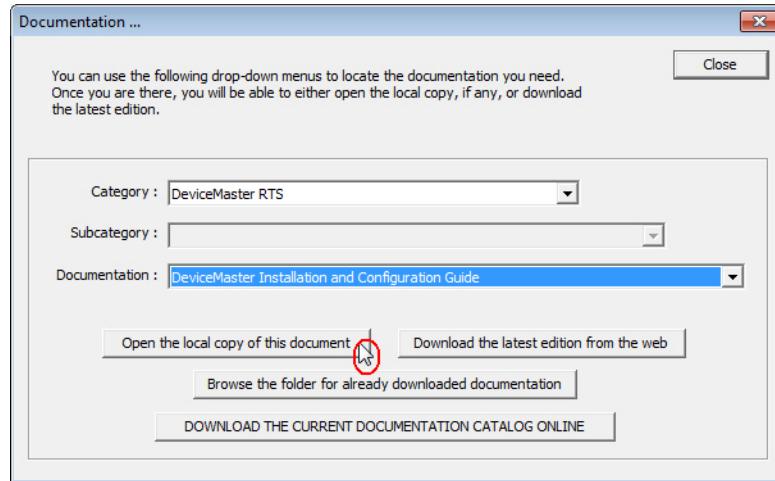

**Note:** *If the document fails to open, it may be that your browser has been disabled. You can still access the document by clicking the **Browse the folder for already downloaded documentation** button and opening the document with your custom browser.*

4. Click **Close** in the *Documentation...* popup, unless you want to open or download other documents.



# Connecting Serial Devices

This section discusses connecting your serial devices to the DeviceMaster UP. It also provides you with information to build serial cables and loopback connectors to test the serial ports.

- [DB9 Connectors](#)
- [RJ45 Connectors](#) on Page 45
- [Screw Terminals \(9\) - DeviceMaster UP 1-Port \(DIN Rail\)](#) on Page 51
- [Screw Terminals \(9\) - DeviceMaster UP 1-Port \(DIN Rail\)](#) on Page 51
- [Screw Terminals \(9\) - DeviceMaster UP 1-Port \(DIN Rail\)](#) on Page 51



**Make sure that you have configured the ports for the correct communications mode before connecting any devices. The default mode is RS-232. There is a remote possibility that connecting a serial device for the wrong mode could damage the serial device.**

**Note:** If you have a DeviceMaster UP with 16-ports, use the DeviceMaster UP 16-Port Hardware User Guide because the RJ45 connectors are different.

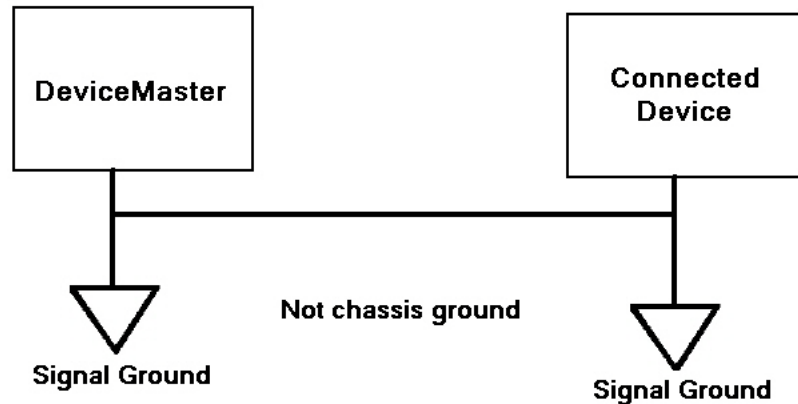

## DB9 Connectors

This subsection provides the following information:

- Connector pin assignments (below)
- [DB9 Null-Modem Cables \(RS-232\)](#) on Page 43
- [DB9 Null-Modem Cables \(RS-422\)](#) on Page 43
- [DB9 Straight-Through Cables \(RS-232/485\)](#) on Page 43
- [DB9 Loopback Plugs](#) on Page 44
- [Connecting DB9 Serial Devices](#) on Page 44

<b>DB9 Connector Pinouts</b>			
<b>Pin</b>	<b>RS-232</b>	<b>RS-422 RS-485 Full-Duplex (Master/Slave)†</b>	<b>RS-485 Half-Duplex</b>
1	DCD	Not used	Not used
2	RxD	RxD-	Not used
3	TxD	TxD-	TRxD-
4	DTR	Not used	Not used
5	GND	GND	GND
6	DSR	Not used	Not used
7	RTS	TxD+	TRxD+
8	CTS	RxD+	Not used
9	RI	Not used	Not Used
† The following models support RS-485 full-duplex: <ul style="list-style-type: none"> <li>• 1-Port DIN rail models</li> <li>• 2-Port DIN rail models</li> <li>• 4-Port DIN rail models</li> </ul>			

Refer to the hardware manufacturer’s installation documentation if you need help with connector pinouts or cabling for the serial device. This illustrates the DB9 connector signals.

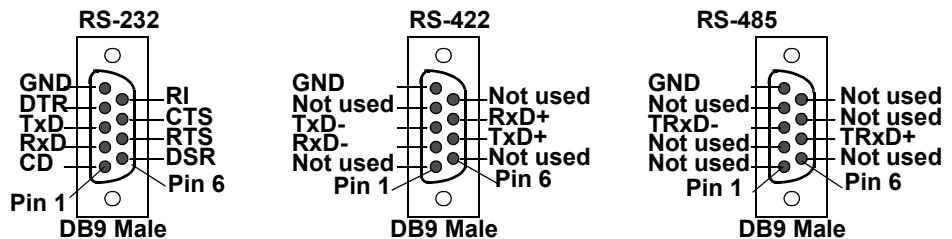

**DB9 Null-Modem Cables (RS-232)**

Use the following figure if you need to build an RS-232 null-modem cable. A null-modem cable is required for connecting DTE devices.

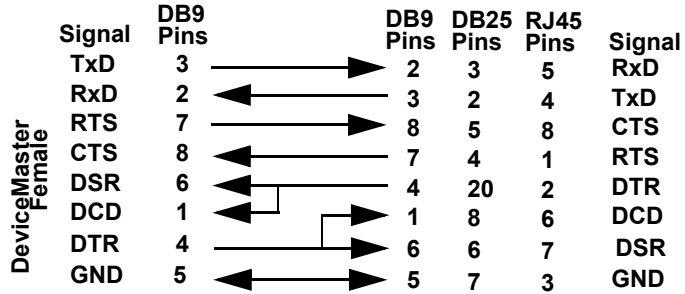

**Note:** You may want to purchase or build a straight-through cable and purchase a null-modem adapter.

**DB9 Null-Modem Cables (RS-422)**

Use the following figure if you need to build an RS-422 null-modem cable.

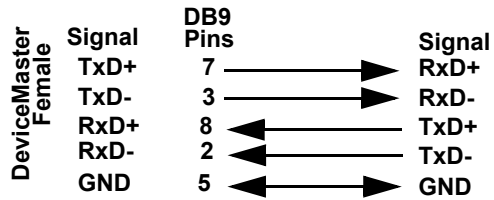

**Note:** RS-422 pinouts are not standardized. Each peripheral manufacturer uses different pinouts. Refer to the peripheral documentation to determine the pinouts for the signals above.

**DB9 Straight-Through Cables (RS-232/485)**

Use the following figure if you need to build an RS-232 or RS-485 straight-through cable. Straight-through cables are used to connect modems and other DCE devices. For example, a straight-through cable can be used to connect COM2 to a modem.

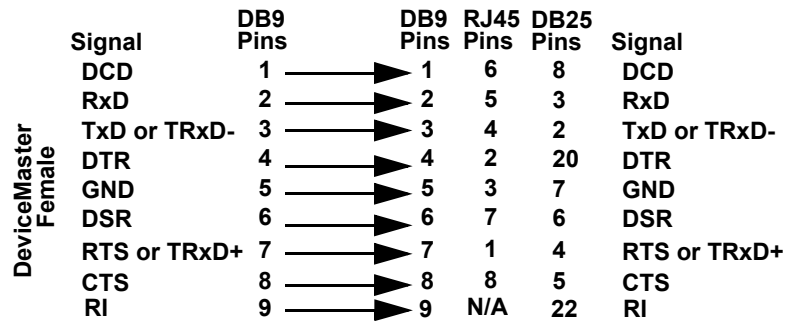

### DB9 Loopback Plugs

Loopback connectors are DB9 female serial port plugs with pins wired together that are used in conjunction with application software to test serial ports. The DeviceMaster UP is shipped with a single loopback plug (RS-232/422).

Not all DeviceMaster UP protocols provide test (example programs). Refer to the [EtherNet/IP User Guide](#) and [Modbus/TCP User Guide](#) for information about using those example programs.

The following DeviceMaster UP protocols do not use the loopback plug:

- Modbus Router
- Modbus Server
- PROFINET IO

Wire the following pins together to build additional plugs or replace a missing RS-232 loopback plug:

- Pins 1 to 4 to 6
- Pins 2 to 3
- Pins 7 to 8 to 9

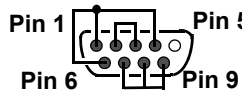

RS-232 Only  
(Back View)

The RS-232 loopback plug also works for RS-422.

Wire the following pins together for an RS-422 loopback plug:

- Pins 2 to 3
- Pins 7 to 8

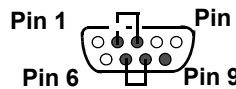

RS-422 Only  
(Back View)

### Connecting DB9 Serial Devices

You can use this information to connect serial devices to DB9 connectors.

1. Connect your serial devices to the appropriate serial port on the DeviceMaster UP using the appropriate cable.

**Note:** Refer to the hardware manufacturer's installation documentation if you need help with connector pinouts or cabling for the peripheral device.

2. DeviceMaster UP 4-port, : verify that the devices are communicating properly.

**Note:** DeviceMaster UP 1-port, 2-port models, and the 4-port DIN models do not have TX/RX LEDs.



\* Represents port number.

The RX (yellow) and TX (green) LEDs function accordingly when the cable is attached properly to a serial device.

- After power cycling the DeviceMaster UP (appropriate models), the RX/TX LEDs are off.
  - The LEDs do not function as described until the port has been opened by an application.
3. You can refer to [Network and Device LEDs](#) on Page 89 for information about the remaining LEDs.

## RJ45 Connectors

This subsection provides the following information:

- Connector pin assignments (below)
- [RJ45 Null-Modem Cables \(RS-232\)](#)
- [RJ45 Null-Modem Cables \(RS-422\)](#) on Page 46
- [RJ45 Straight-Through Cables \(RS-232/485\)](#) on Page 46
- [RJ45 Loopback Plugs](#) on Page 46
- [RJ45 RS-485 Test Cable](#) on Page 46
- [Connecting RJ45 Devices](#) on Page 47

You can build your own null-modem or straight-through RJ45 serial cables if you are using the DB9 to RJ45 adapters using the following subsections.

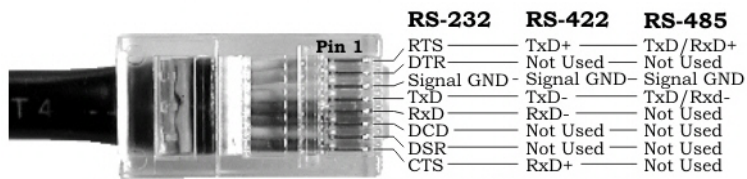

Pin	RS-232	RS-422	RS-485
1	RTS	TxD+	TRxD+
2	DTR	Not used	Not used
3	Signal GND	Signal GND	Signal GND
4	TxD	TxD-	TRxD-
5	RxD	RxD-	Not used
6	DCD	Not used	Not used
7	DSR	Not used	Not used
8	CTS	RxD+	Not used

### RJ45 Null-Modem Cables (RS-232)

Use the following figure if you need to build an RS-232 null-modem cable. A null-modem cable is required for connecting DTE devices.

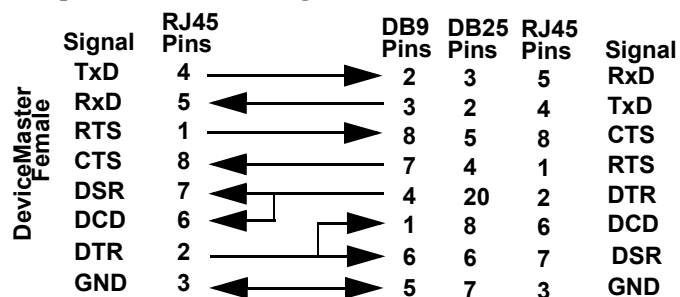

**Note:** You may want to purchase or build a straight-through cable and purchase a null-modem adapter. For example, a null-modem cable can be used to connect COM2 of one PC to COM2 of another PC.

**RJ45 Null-Modem Cables (RS-422)**

Use the following figure if you need to build an RS-422 null-modem RJ45 cable. A null-modem cable is required for connecting DTE devices.

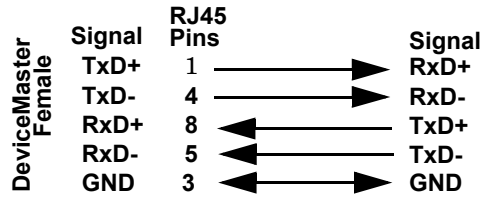

**Note:** RS-422 pinouts are not standardized. Each peripheral manufacturer uses different pinouts. Please refer to the documentation for the peripheral to determine the pinouts for the signals above.

**RJ45 Straight-Through Cables (RS-232/485)**

Use the following figure if you need to build an RS-232 or RS-485 straight-through cable. Straight-through cables are used to connect modems and other DCE devices. For example, a straight-through cable can be used to connect COM2 of one PC to COM2 to a modem.

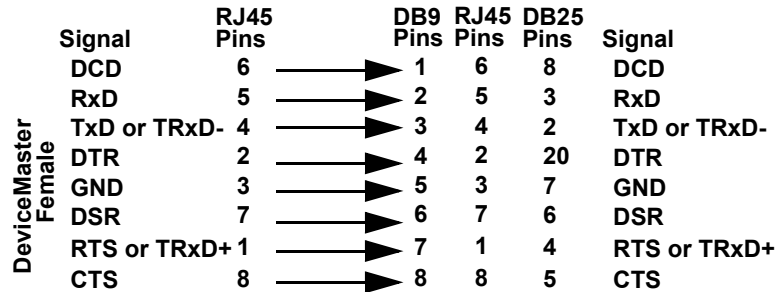

**RJ45 Loopback Plugs**

Loopback connectors are RJ45 serial port plugs with pins wired together that are used in conjunction with application software to test serial ports. The DeviceMaster UP is shipped with a single loopback plug (RS-232/422).

- Pins 4 to 5
- Pins 1 to 8
- Pins 2 to 6 to 7

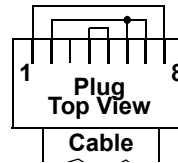

The RS-232 loopback plug also works for RS-422.

Not all DeviceMaster UP protocols provide test (example programs). Refer to the [EtherNet/IP User Guide](#) and [Modbus/TCP User Guide](#) for information about using the example programs.

The following DeviceMaster UP protocols do not use the loopback plug:

- Modbus Router
- Modbus Server
- PROFINET IO

**RJ45 RS-485 Test Cable**

You can use a straight-through cable as illustrated previously, or build your own cable.

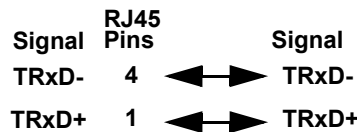

**Note:** RS-422 pinouts are not standardized. Each peripheral manufacturer uses different pinouts. Please refer to the documentation for the peripheral to

determine the pinouts for the signals above.

## Connecting RJ45 Devices

You can use this information to connect serial devices to RJ45 connectors.

1. Connect your serial devices to the appropriate serial port on the DeviceMaster UP using the appropriate cable.

**Note:** Refer to the hardware manufacturer's installation documentation if you need help with connector pinouts or cabling for the peripheral device.

2. If the DeviceMaster UP has RX/TX LEDs, verify that the devices are communicating properly.

The RX (yellow) and TX (green) LEDs function accordingly when the cable is attached properly to a serial device.

- After power cycling the DeviceMaster UP, the RX/TX LEDs are off.
- The LEDs do not function as described until the port has been opened by an application.

3. You can refer to [Network and Device LEDs](#) on Page 89 for information about the remaining LEDs.

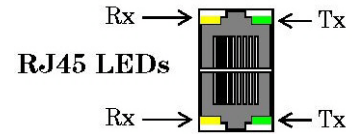

## Screw Terminals (4) - DeviceMaster UP 2-Port 1E

This subsection discusses the following topics for the DeviceMaster UP 2-port 1E with serial terminals (4).

- [Serial Terminal \(4\) Connectors](#) on Page 48
- [Serial Terminal \(4\) Null-Modem Cables \(RS-232\)](#) on Page 49
- [Serial Terminal \(4\) Null-Modem Cables \(RS-422\)](#) on Page 49
- [Serial Terminal \(4\) Straight-Through Cables \(RS-232/485\)](#) on Page 49
- [Serial Terminal \(4\) Loopback Signals](#) on Page 50
- [Connecting Serial Devices](#) on Page 50

### Serial Terminal (4) Connectors

Use the following table or drawings for signal information. The signals for SERIAL2 are the same as SERIAL1.

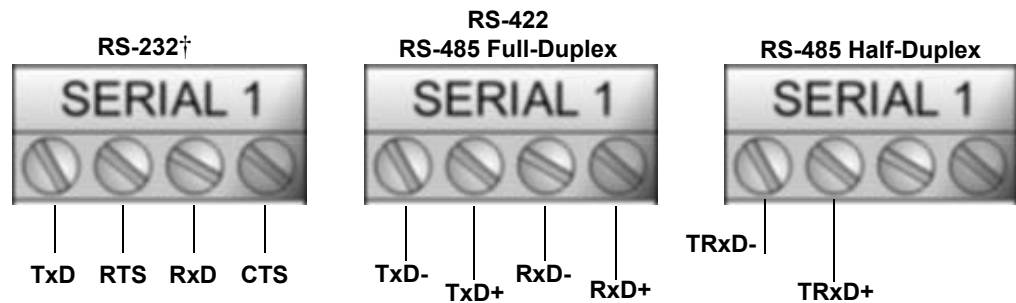

† RS-232 ground must be connected to the appropriate signal ground

### RS-232: Connecting the Ground

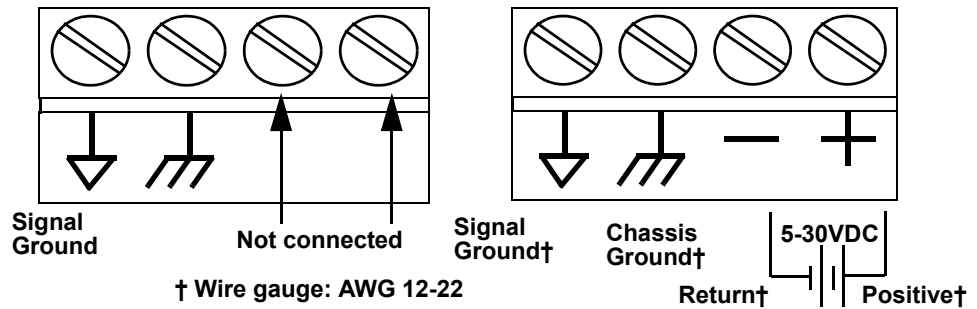

<b>RS-232†</b>	TxD	RTS	RxD	CTS
<b>RS-422/RS-485 Full-Duplex</b>	TxD-	TxD+	RxD-	RxD+
<b>RS-485 Half-Duplex</b>	TRxD-	TRxD+		

† RS-232 ground must be connected to the signal ground terminal.



**Serial Terminal (4) Null-Modem Cables (RS-232)**

An RS-232 null-modem cable is required for connecting DTE devices.

RS-232 Null-Modem Cable

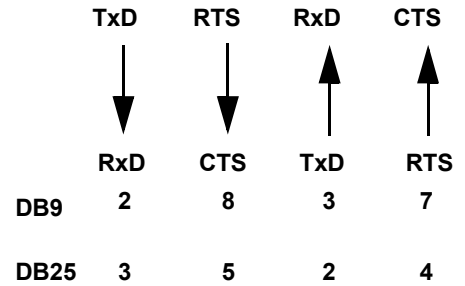
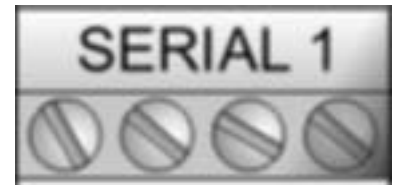

**Serial Terminal (4) Null-Modem Cables (RS-422)**

An RS-422 null-modem cable is required for connecting DTE devices.

*Note: RS-422 pinouts are not standardized. Each peripheral manufacturer uses different pinouts. Please refer to the documentation for the peripheral to determine the pinouts for the signals above.*

RS-422 Null-Modem Cable

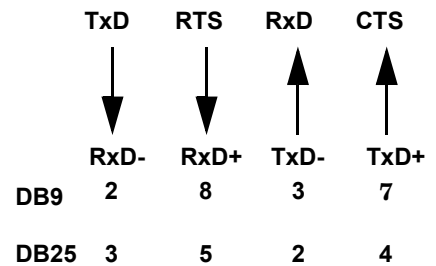

**Serial Terminal (4) Straight-Through Cables (RS-232/485)**

RS-232 or RS-485 straight-through cables are used to connect modems and other DCE devices.

RS-232/422 Straight-Through Cable

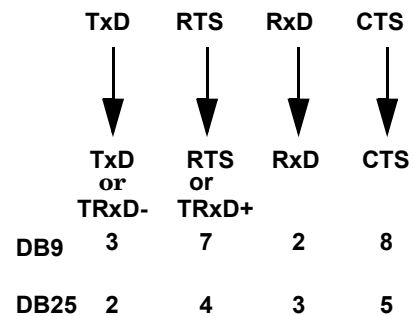

### Serial Terminal (4) Loopback Signals

Use this drawing to wire a loopback, which is used in conjunction with application software to test serial ports.

Wire the terminals together to create a loopback.

- TxD to RxD
- RTS to CTS

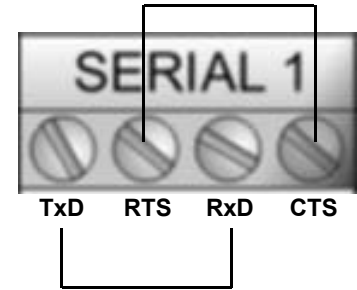

### Connecting Serial Devices

Use the following information to connect the DeviceMaster UP 2-port 1E with serial terminals.

1. Connect your serial devices to the appropriate serial port on the DeviceMaster UP using the appropriate cable. You can build your own cables or loopbacks using the appropriate discussions.

**Note:** Refer to the hardware manufacturer's installation documentation if you need help with connector pinouts or cabling for the serial device.

2. You can refer to [Network and Device LEDs](#) on Page 89 for information about the LEDs.

## Screw Terminals (9) - DeviceMaster UP 1-Port (DIN Rail)

This subsection discusses the following topics for the DeviceMaster UP 1-port DIN rail with serial screw terminals.

- [Screw Terminal Connectors \(9\)](#) on Page 51
- [Screw Terminal \(9\) Null-Modem RS-232 Cables](#) on Page 51
- [Screw Terminal \(9\) Null-Modem RS-422 Cables](#) on Page 52
- [Screw Terminal \(9\) RS-232/485 Straight-Through Cables](#) on Page 52
- [Screw Terminal \(9\) Loopback Signals](#) on Page 52
- [Connecting Serial Devices](#) on Page 53

### Screw Terminal Connectors (9)

Use the following table or drawings for signal information.

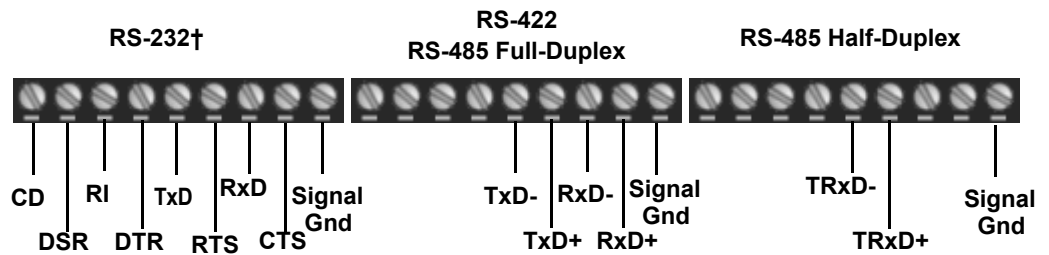

† RS-232 ground must be connected to the signal ground terminal.

RS-232	CD	DSR	RI	DTR	TxD	RTS	RxD	CTS	Sig Gnd
<b>RS-422/RS-485 Full-Duplex</b>	N/A	N/A	N/A	N/A	TxD-	TxD+	RxD-	RxD+	Sig Gnd
<b>RS-485 Half-Duplex</b>	N/A	N/A	N/A	N/A	TRxD-	TRxD+	N/A	N/A	Sig Gnd
† RS-232 ground must be connected to the signal ground terminal.									

### Screw Terminal (9) Null-Modem RS-232 Cables

An RS-232 null-modem cable is required for connecting DTE devices.

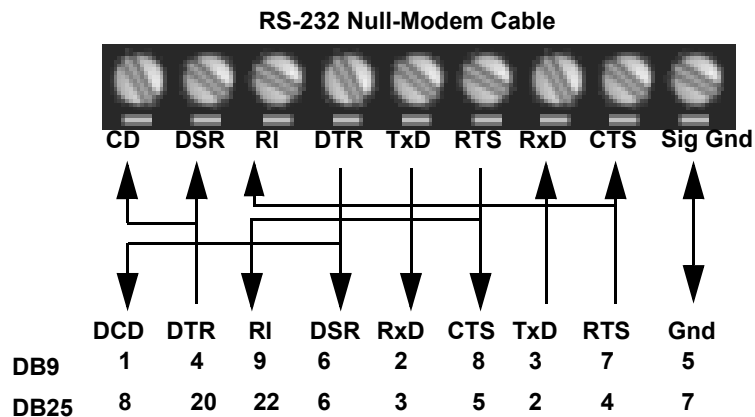

**Screw Terminal (9)  
Null-Modem RS-422  
Cables**

An RS-422 null-modem cable is required for connecting DTE devices.

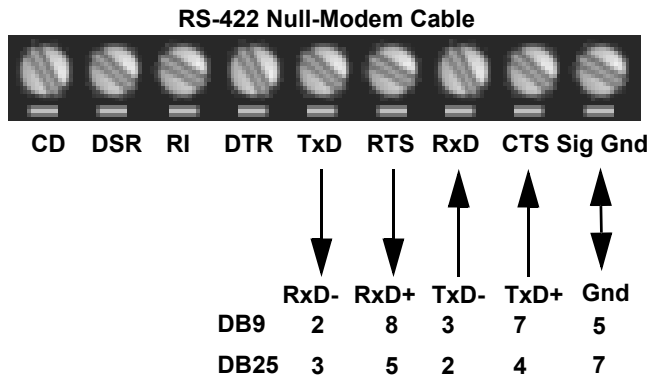

*Note: RS-422 pinouts are not standardized. Each peripheral manufacturer uses different pinouts. Please refer to the documentation for the peripheral to determine the pinouts for the signals above.*

**Screw Terminal (9)  
RS-232/485 Straight-  
Through Cables**

RS-232 or RS-485 straight-through cables are used to connect modems and other DCE devices.

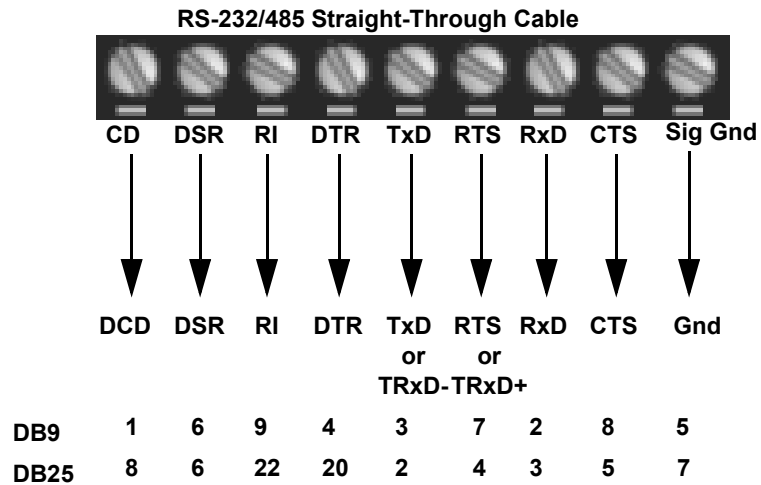

**Screw Terminal (9)  
Loopback Signals**

Use this drawing to wire a loopback, which is used in conjunction with application software to test serial ports.

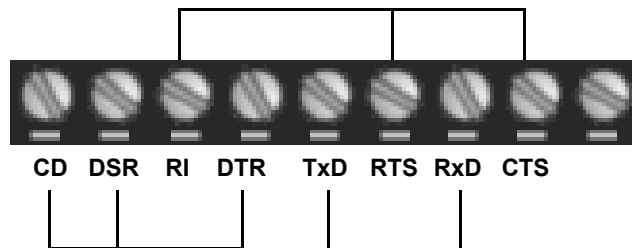

Wire the terminals together to create a loopback.

- TxD to RxD
- RTS to CTS to RI
- DTR to CD to DSR

## Connecting Serial Devices

Use the following information to connect the DeviceMaster UP 2-port 1E with serial terminals.

1. Connect your serial devices to the appropriate serial port on the DeviceMaster UP using the appropriate cable. You can build your own cables or loopbacks using the appropriate discussions.

**Note:** Refer to the hardware manufacturer's installation documentation if you need help with connector pinouts or cabling for the serial device.

2. You can refer to [Network and Device LEDs](#) on Page 89 for information about the LEDs.



# Managing the DeviceMaster UP

This section discusses the following DeviceMaster UP maintenance procedures:

- *Rebooting the DeviceMaster UP*
- [Uploading Firmware to Multiple DeviceMaster UPs](#) on Page 56
- [Configuring Multiple DeviceMaster UPs Network Addresses](#) on Page 57  
**Note:** You can configure the network addresses for multiple DeviceMaster UPs, configure common settings for the DeviceMaster UPs, and save the settings to a configuration file that you can use to load settings up to all or selected DeviceMaster UPs.
- [Adding a New Device in PortVision DX](#) on Page 57
- [Using Configuration Files](#) on Page 59
- [Managing Bootloader](#) on Page 61, which also discusses checking the Bootloader version and downloading the latest Bootloader
- [Accessing RedBoot Commands in Telnet/SSH Sessions \(PortVision DX\)](#) on Page 64

**Note:** You can optionally refer to [RedBoot Procedures](#) on Page 67 if you want to perform procedures at the RedBoot level.

## Rebooting the DeviceMaster UP

---

---

There are many ways to reboot the DeviceMaster UP.

Method	Procedure
PortVision DX	Right-click the DeviceMaster UP or DeviceMaster UPs in the <i>Device List</i> pane, click <b>Advanced &gt;Reboot</b> and then <b>Yes</b> . <b>Note:</b> If security has been enabled in the web page, you will need to reboot the DeviceMaster UP in the web page.
Web page	<i>Main page (Server Status):</i> Scroll to the bottom of the page, click <b>Reboot</b> and then <b>Yes: Reboot</b> .
Telnet	Type <b>reset</b> .
DeviceMaster UP DIN Rail Models	DeviceMaster UP DIN rail models have a <b>Reset/Restore</b> switch. <ul style="list-style-type: none"><li>• If the <b>Reset/Restore</b> switch is depressed for less than 2 seconds, the DeviceMaster UP DIN rail reboots.</li><li>• If the <b>Reset/Restore</b> switch is depressed for greater than approximately 5 seconds it restores the DeviceMaster UP to the factory default values.</li></ul>

## Uploading Firmware to Multiple DeviceMaster UPs

You can use this procedure if your DeviceMaster UP is connected to the host PC, laptop, or if the DeviceMaster UP resides on the local network segment.

1. If you have not done so, install PortVision DX ([Installing PortVision DX](#) on Page 39) and Scan the network.
2. Shift-click the multiple DeviceMaster UPs on the **Main** screen that you want to update and use one of the following methods:
  - Click the **Upload** button.
  - Right-click and then click **Advanced > Upload Firmware**.
  - Click **Advanced > Upload Firmware** in the **Manage** menu.

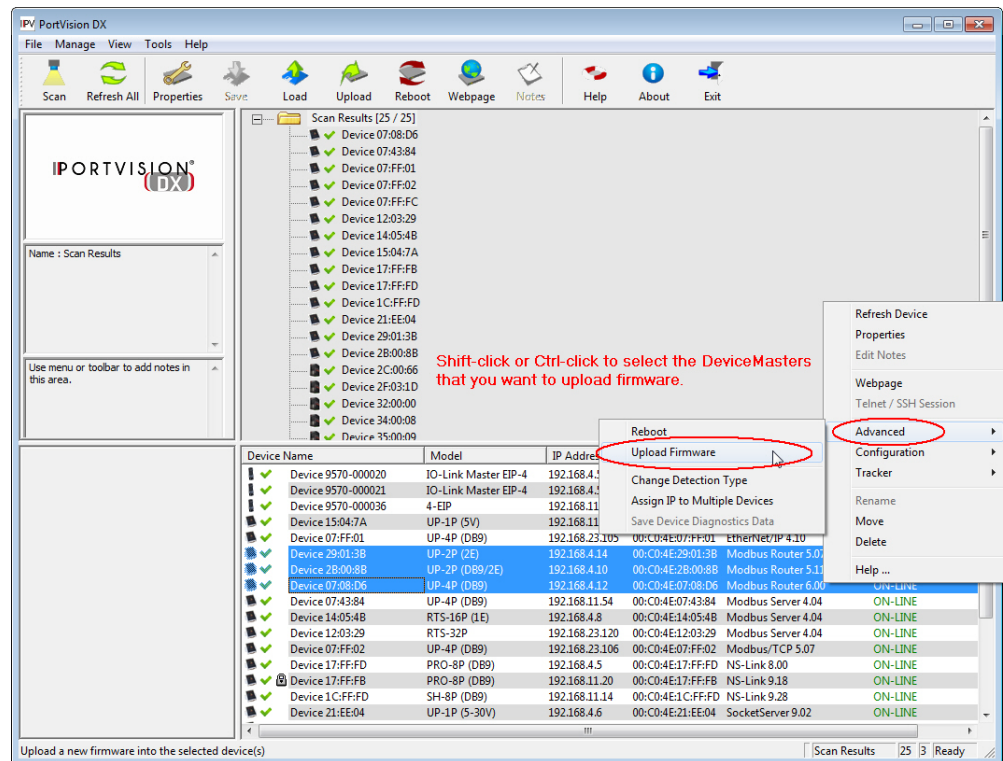

3. Browse, click the firmware (.cmtl) file, **Open** (*Please locate the new firmware*), and then click **Yes** (*Upload Firmware*).

It may take a few moments for the firmware to upload onto the DeviceMaster UP. The DeviceMaster UP reboots itself during the upload process.

4. Click **Ok** to the advisory message about waiting to use the device until the status reads **ON-LINE**.

In the next polling cycle, PortVision DX updates the *Device List* pane and displays the new firmware version.



## Configuring Multiple DeviceMaster UPs Network Addresses

You can configure the network addresses for multiple DeviceMaster UPs using the **Assign IP to Multiple Devices** option.

In addition, you can also configure common settings for the DeviceMaster UP web page and save the settings to a configuration file that you can load to all or selected DeviceMaster UPs. See [Using Configuration Files](#) on Page 59 for more information.

The DeviceMaster UPs must be on the same network segment for this procedure to work. Use the following steps to configure multiple DeviceMaster UPs.

1. If you have not done so, install PortVision DX ([Installing PortVision DX](#) on Page 39) and **Scan** the network.
2. Shift-click the DeviceMaster UPs for which you want to program network information, right-click, and click **Advanced > Assign IP to Multiple Devices**.
3. Enter the starting IP address, subnet mask, IP Gateway and click **Proceed**.

PortVision DX displays the programmed IP addresses in the *Device List* pane after the next refresh cycle.

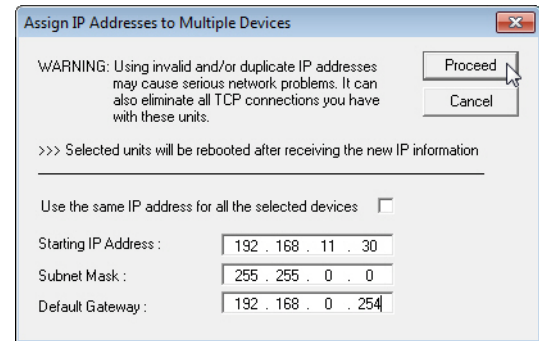

## Adding a New Device in PortVision DX

You can add a new DeviceMaster UP manually, if you do not want to scan the network to locate and add new DeviceMaster UPs, but there may be cases where you want to use the *Add New Device* window to:

- Configure DeviceMaster UP units that are not on the local network (remote) using [Remote Using the IP Address](#) on Page 57.
- Pre-configure a DeviceMaster UP in PortVision DX (local) using [Local Using the IP Address or MAC Address](#) on Page 58.

### Remote Using the IP Address

Use the following procedure to add a remote DeviceMaster UP to PortVision DX.

1. Access the *New Device* window using one of these methods:
  - Click **Add New > Device** in the *Manage* menu.
  - Right-click a folder or a RocketLinux switch in the *Device Tree* pane (anywhere in the pane, as long as a DeviceMaster UP is not highlighted and you are in a valid folder) and click **Add New > Device**.
2. Select the appropriate DeviceMaster UP in the **Device Type** drop list.
3. Select the appropriate model in the **Device Model** drop list.
4. Enter a friendly device name in the **Device Name** list box.
5. Select **REMOTE** for the *Detection Type*.
6. Optionally, enter the serial number in the **Serial Number** list box.

7. Enter the IP Address for the DeviceMaster UP. It is not necessary to enter the Subnet Mask and Default Gateway.

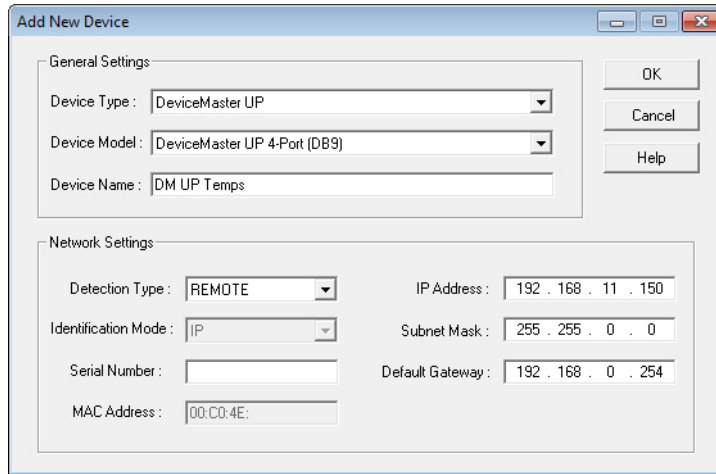

8. Click **Ok** to close the *Add New Device* window. It may take a few moments to save the DeviceMaster UP.
9. If necessary, click **Refresh** for the new DeviceMaster UP to display in the *Device Tree* or *Device List* panes. The DeviceMaster UP shows OFF-LINE if it is not attached to the network or if an incorrect IP address was entered.

**Local Using the IP Address or MAC Address**

Use the following procedure to add a local DeviceMaster UP to PortVision DX if you do not want to scan the network.

1. Locate the network information or MAC address of the DeviceMaster UP you want to add.
2. Access the *New Device* window using one of these methods:
  - Click **Add New > Device** in the *Manage* menu.
  - Right-click a folder or a RocketLinx switch in the *Device Tree* pane (anywhere in the pane, as long as a DeviceMaster UP is not highlighted and you are in a valid folder) and click **Add New > Device**.
3. Select the DeviceMaster UP in the **Device Type** drop list.

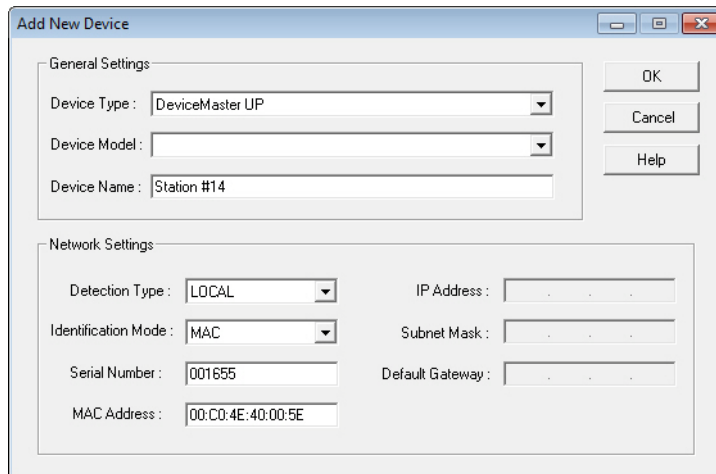

4. Select the appropriate model in the **Device Model** drop list.
5. Enter a friendly device name in the **Device Name** list box.

6. Select **LOCAL** for the *Detection Type*.
7. Enter the MAC address or network information.  
*Note: A MAC address label is attached to all DeviceMaster UP units. The first three pairs of digits start with 00 C0 4E.*
8. Optionally, enter the serial number in the **Serial Number** list box.
9. Click **Ok**.
10. If necessary, click **Refresh** for the new DeviceMaster UP to display in the *Device Tree* or *Device List* panes. The DeviceMaster UP shows OFF-LINE if it is not attached to the network or if an incorrect IP address was entered.

## Using Configuration Files

If you are deploying multiple DeviceMaster UP units that share common firmware values, you can save the configuration file (.dc) from the *Main* or **Properties > Software Settings** tab in PortVision DX and load that configuration onto other DeviceMaster UP units.

If you save a configuration file from the *Main* or **Software Settings** tab on the *Properties* screen, you can choose what settings you want saved or loaded.

You may want to program the network settings in multiple DeviceMaster UPs using [Configuring Multiple DeviceMaster UPs Network Addresses](#) on Page 57.

### Saving a Configuration File

Use this procedure to save a configuration file using the *Main* screen.

*Note: Optionally, you can save a configuration file by accessing the **Software Settings** tab in the *Properties* screen and then clicking the **Save Settings to a File** button.*

1. If you have not done so, install PortVision DX ([Installing PortVision DX](#) on Page 39) and **Scan** the network.
2. Highlight the DeviceMaster UP in the *Device List* pane that you want to save its configuration and use one of the following methods:
  - Click the **Save** button.
  - Right-click and then click **Configuration > Save**.
3. Browse to the location you want to save the file, enter a file name, and click **Save**.
4. Click the **All** check box or click only the properties that you want saved for each property page in the configuration file and click **Done**.
5. Click **Ok** to close the *Save Configuration Completed* message.

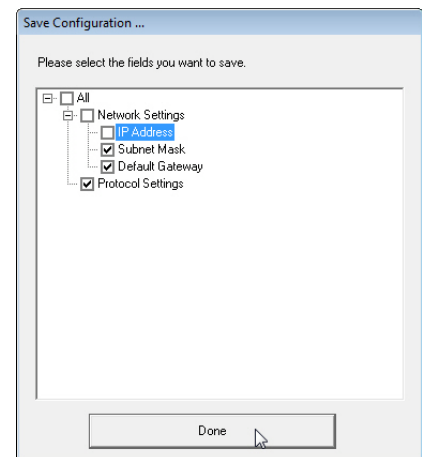

## Loading a Configuration File

Use the following procedure to load a previously saved a DeviceMaster UP configuration file. Load a configuration file and apply it to a selected DeviceMaster UP or DeviceMaster UPs from the *Main* screen or the **Software Settings** tab on the *Properties* screen.

Use this procedure to load a configuration file using the *Device List* pane to one or more DeviceMaster UP units.

**Note:** *The configuration file does not need to be the same model or port density. For example, the saved configuration file could be from a DeviceMaster PRO 8-port that you want to load on a DeviceMaster RTS 1-port.*

1. Highlight the device or devices in the *Device List* pane that you want to load and use one of the following methods:

- Click the **Load** button
- Right-click and then click **Configuration > Load**

2. Click **Yes** to the warning that it will take 25 seconds per device and it may also reboot the devices.

3. Browse to the location of the configuration file, click the file name (.dc) and then **Open**.

4. Click the **All** check box or click only the properties that you want to load for each property page in the configuration file and then click **Done**.

**Note:** *If you click All, every selected DeviceMaster UPs will be programmed with the same IP address.*

5. Close the *Load Configuration* popup message.

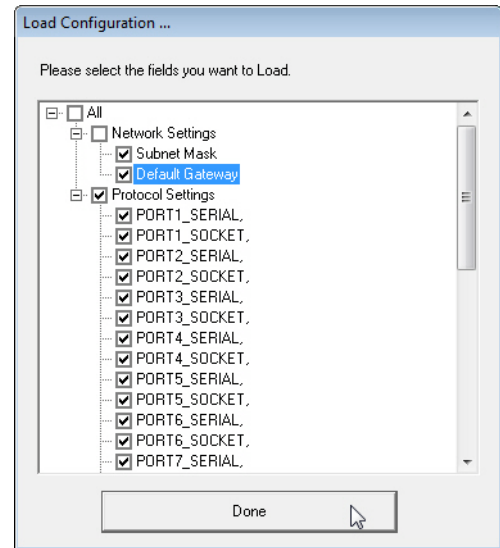

## Managing Bootloader

*Bootloader* refers to the operating system that runs on the DeviceMaster UP hardware during the power on phase, which then loads the default application (for example, Modbus Router or EtherNet/IP firmware).

**Note:** Typically, you should not update the Bootloader unless advised to do so by Control Technical Support.

There are several methods and tools that you can use to check the Bootloader version or update the Bootloader.

- **PortVision DX** is the easiest way to check the Bootloader version and upload the latest version.
- Optionally, RedBoot can be used to check the Bootloader version and update the Bootloader. See [RedBoot Procedures](#) on Page 67 for procedures.

### Checking the Bootloader Version

The following procedure uses PortVision DX to check the Bootloader version. Optionally, you can use RedBoot, see [Determining the Bootloader Version](#) on Page 71.

1. If you have not done so, install PortVision DX ([Installing PortVision DX](#) on Page 39) and **Scan** the network.
2. Right-click the DeviceMaster UP in the *Device List* pane and click **Advanced > Reboot**.
3. Click **Yes** to the *Confirm Reboot* query.
4. Right-click the DeviceMaster UP in the *Device List* pane, click **Refresh**. You may need to do this several times until you catch the reboot cycle in the *Device List* pane. The Bootloader version is briefly displayed during the reboot cycle before the application (for example, Modbus Router or EtherNet/IP firmware) loads.
5. Check the Control web site to see if [a later version](#) is available.
6. Go to the next subsection if you need upload a new version of Bootloader.

### Uploading Bootloader

Use the following procedure to upload Bootloader to the DeviceMaster UP. Typically, you should not update the Bootloader unless advised to do so by Control Technical Support or a notice has been posted to the firmware download page on the ftp site.

**Note:** Technical Support does not recommend updating Bootloader across a WAN. For best results, connect the DeviceMaster UP directly to a PC or laptop to upload Bootloader.

**Make sure that power is not interrupted while uploading Bootloader. Power interruption while uploading Bootloader will require that the DeviceMaster UP must be sent into Control so that it can be reflashed.**

**If you are not successful uploading firmware into the DeviceMaster UP, do not upload Bootloader.**



Caution

1. If you have not done so, install PortVision DX ([Installing PortVision DX](#) on Page 39) and **Scan** the network.
2. If necessary, check the Bootloader version ([Checking the Bootloader Version](#)) and download the latest version.

- Right-click the DeviceMaster UP for which you want to update, click **Advanced > Upload Firmware**, browse to the Bootloader .cmtl file, and then click **Open**.

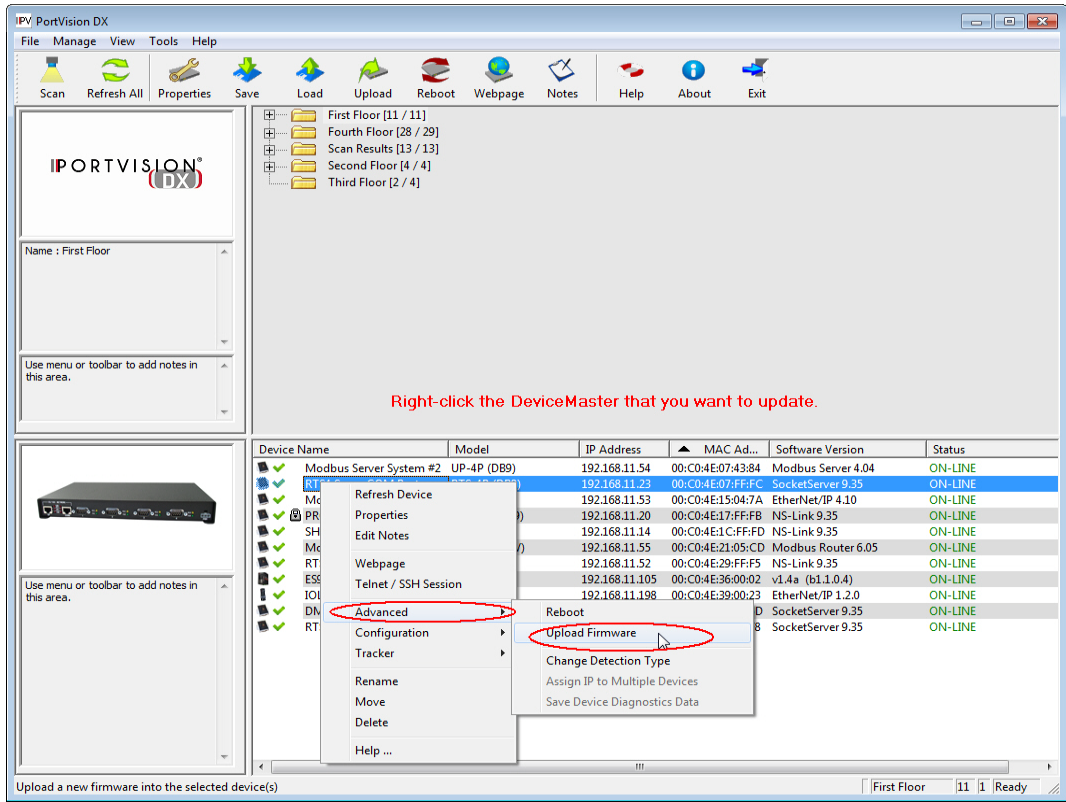

- Click **Yes** to the *Upload Firmware* message that warns you that this is a sensitive process.

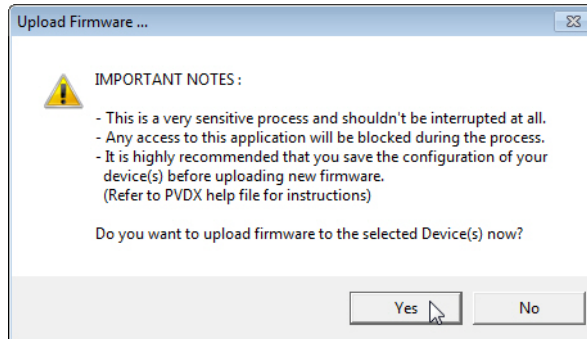

- Click **Ok** to the second *Upload Firmware* message.
- Right-click the DeviceMaster UP and click **Refresh** until the Bootloader version displays in the *Device List* pane and verify that the new version loaded.

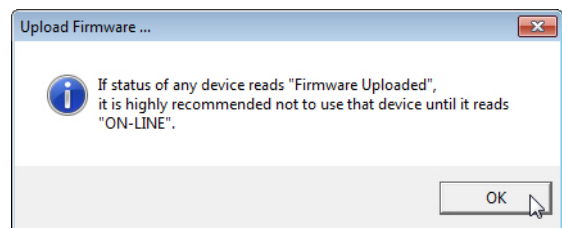

## Restoring Factory Defaults (Specific Models)

---

---

Use the following procedures to restore the following DeviceMaster UP models to the factory defaults:

- DeviceMaster UP 1-port DIN rail models
- DeviceMaster UP 2-port models
- DeviceMaster UP 4-port DIN rail

If Technical Support advises you to restore the DeviceMaster UP factory defaults, depress the **Reset/Restore** switch for greater than 5 seconds.

Restoring the DeviceMaster UP DIN rail models resets the following to their factory defaults:

- Network settings
- Password
- Telnet enable
- Start up time-out
- SSL enable
- Telnet time-out

## Accessing RedBoot Commands in Telnet/SSH Sessions (PortVision DX)

You can open a Telnet or SSH session using PortVision DX to access RedBoot commands.

Use the following procedure to access a telnet or SSH session with PortVision DX.

1. In PortVision DX, right-click the DeviceMaster UP in the *Device List* pane for which you want to open a telnet session, and click **Telnet/SSH Session**.

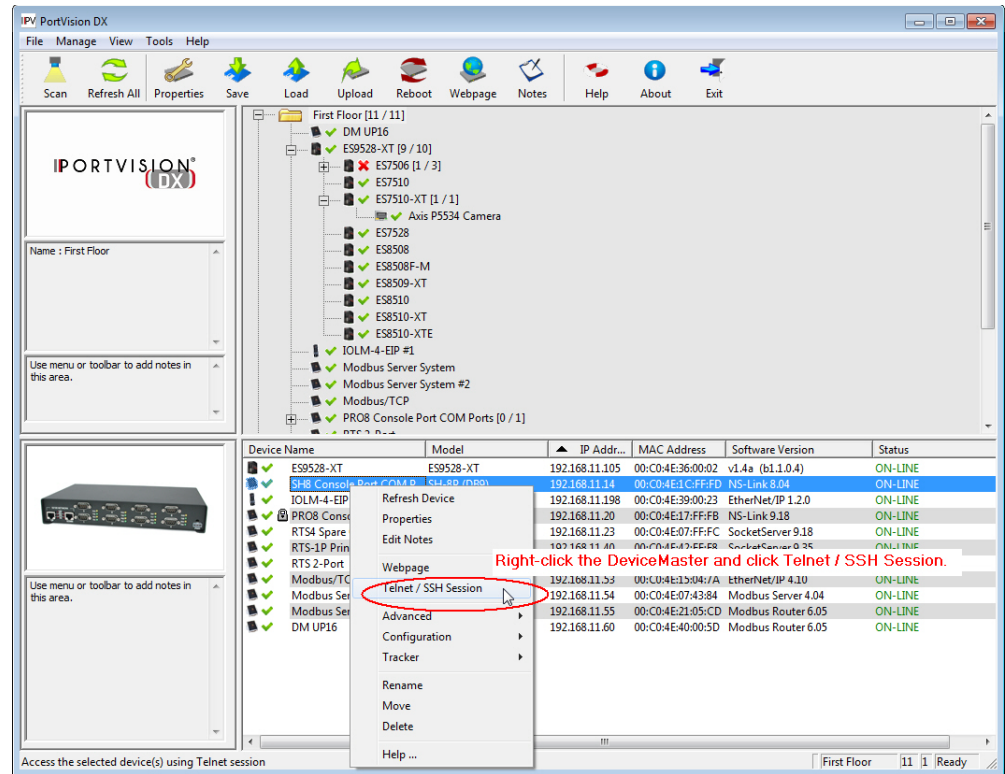

2. Select **Telnet** or **SSH**, leave the **Selected Port** number, and click **Ok**.

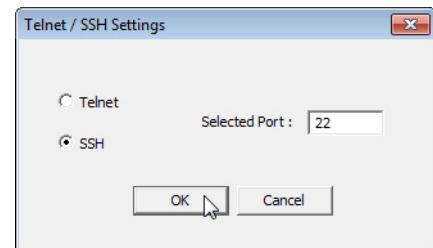
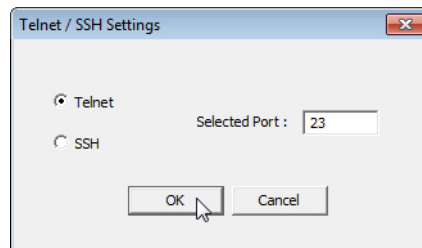



- If necessary, enter the password and press **Enter**. If a password has not been set, press **Enter**. If using an SSH session, press **Enter** to the **login** as prompt.

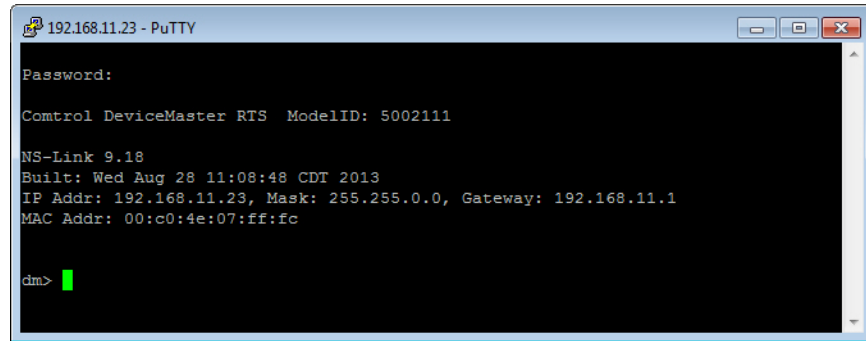

- Type **Reset**, press **Enter**, and close the telnet session.

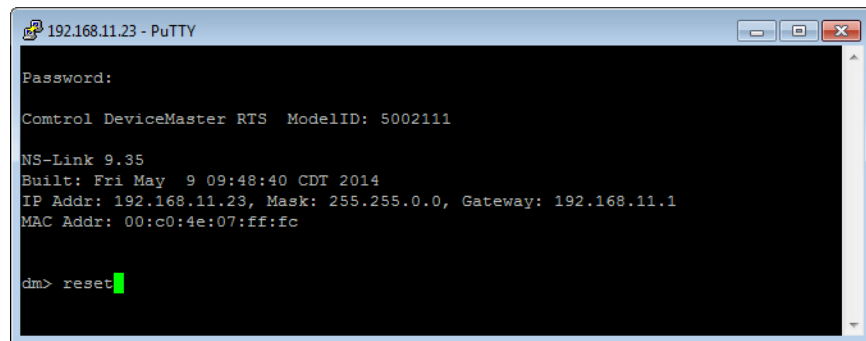

- Quickly re-open the telnet or SSH session using the previous steps.

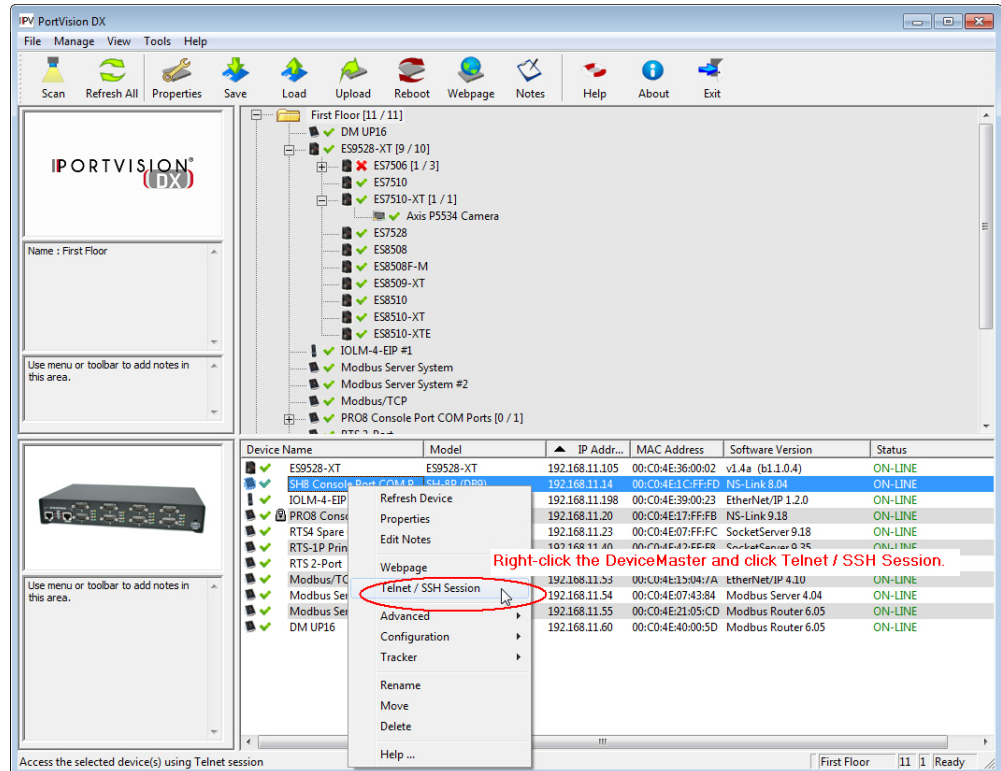

6. Select **Telnet** or **SSH**, leave the **Selected Port** number, and click **Ok**.

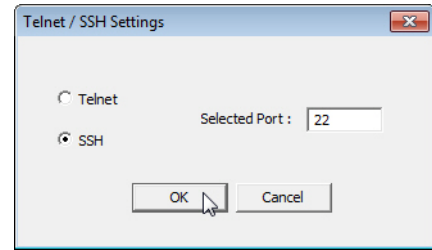
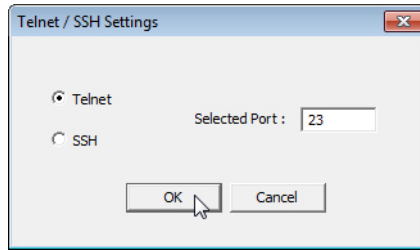

7. Press **Enter**. You can type **help** to review the RedBoot commands. You can also refer to [RedBoot Command Overview](#) on Page 73.

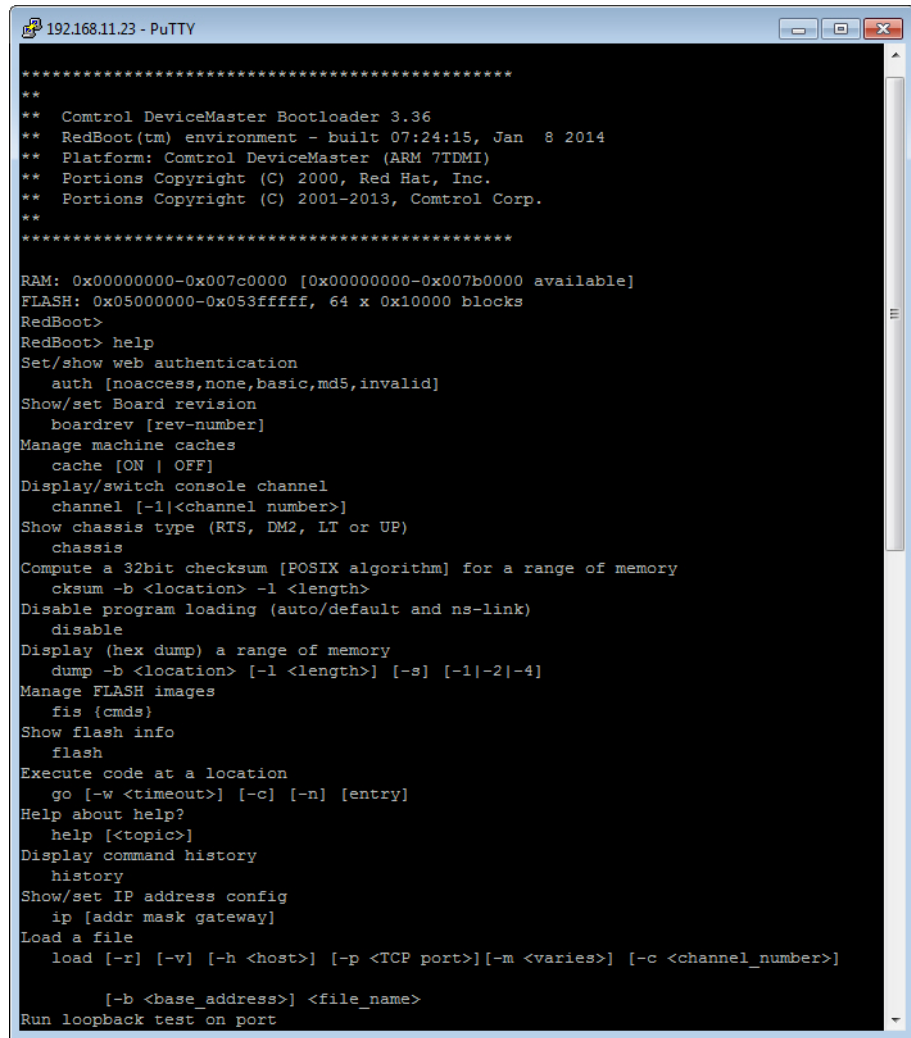

**Note:** The *dm* prompt should be replaced by a *redboot* prompt. If not, you can reset the Bootloader timeout for a longer time period and retry this procedure.

# RedBoot Procedures

You can use this section as a reference if you want to perform tasks in RedBoot.

- [Accessing RedBoot Overview](#) on Page 67
- [Establishing a Serial Connection](#) on Page 68
- [Establishing a Telnet Connection](#) on Page 69
- [Determining the Network Settings](#) on Page 70
- [Configuring the Network Settings](#) on Page 70
- [Changing the Bootloader Timeout](#), Page 71
- [Determining the Bootloader Version](#) on Page 71
- [Resetting the DeviceMaster UP](#) on Page 72
- [Configuring Passwords](#) on Page 72
- [RedBoot Command Overview](#) on Page 73.

Optionally, you can install PortVision DX on a Windows system on the network and perform all of these tasks. PortVision DX provides a Telnet/SSH session, which is discussed in [Accessing RedBoot Commands in Telnet/SSH Sessions \(PortVision DX\)](#) on Page 64.

---

---

## Accessing RedBoot Overview

To access RedBoot, you can use one of the following methods:

- A *serial* connection between Port 1 on the DeviceMaster UP and a COM port on a PC (Page 68). If you plan on using the serial method, you will need a null modem cable, a terminal program installed and configured on the PC, and a **Bootloader Timeout** value in excess of 15 seconds. If the **Bootloader Timeout** value has been reduced to 1 second, this procedure will NOT be possible.

**Note:** Use the serial connection method, if the DeviceMaster UP is not on the same Ethernet network segment as the PC.

If you do not know the IP address of the DeviceMaster UP you must use a serial connection to communicate with the DeviceMaster UP.

- A *telnet* connection (Page 69), if the DeviceMaster UP is locally accessible by Ethernet. A *telnet connection* requires that you know the IP address. In addition, the IP address must also be valid for the network to which it is attached.

For example: The network segment must be 192.168.250.x to telnet to the DeviceMaster UP default IP address if you have not changed the IP address to operate on your network.

## Establishing a Serial Connection

---

---

Use the following procedure to set up a serial connection with a terminal server program. You can use HyperTerminal (Windows) or optionally, Test Terminal (WCom2), which can be accessed from PortVision DX using **Tools > Applications > Test Terminal (WCom2)**.

1. Connect a null-modem cable from an available COM port on your PC to **Port 1** on the DeviceMaster UP.

**Note:** See [Connecting Serial Devices](#) on Page 41, if you need to build a null-modem cable.

2. Configure the terminal server program to the following values:

- Bits per second = 57600
- Data bits = 8
- Parity = None
- Stop bits = 1
- Flow control = None

**Note:** If you do not disable Bootloader from loading (Steps 3 through 5) within the time-out period (default is fifteen seconds), an application will be loaded from flash and started. If this happens, repeat Steps 3 through 5. The **#!DM** command is the only case-sensitive command and must be in uppercase.

3. Reset the DeviceMaster UP.

**Note:** Depending on the model, disconnect and reconnect the power cable (external power supply and no power switch) or turn the power switch on and then off (internal power supply).

4. Immediately type **#!DM** and press **Enter** in the terminal program.

```
#!DM
RedBoot>dis
Loading disabled
```

5. At the **RedBoot>** prompt, type **dis**, and press **Enter**.
6. Verify that loading has been disabled.
7. You can use the appropriate procedure listed on Page 67 or use the [RedBoot Command Overview](#) on Page 73 to perform the desired task.

## Establishing a Telnet Connection

Use the following procedure to telnet to the DeviceMaster UP.

1. Open a telnet session, enter the DeviceMaster UP IP address.  
If using Windows, you can use PortVision DX, see [Accessing RedBoot Commands in Telnet/SSH Sessions \(PortVision DX\)](#) on Page 64.
2. Press the **Enter** key if you did not program a password or type the password and press **Enter**.

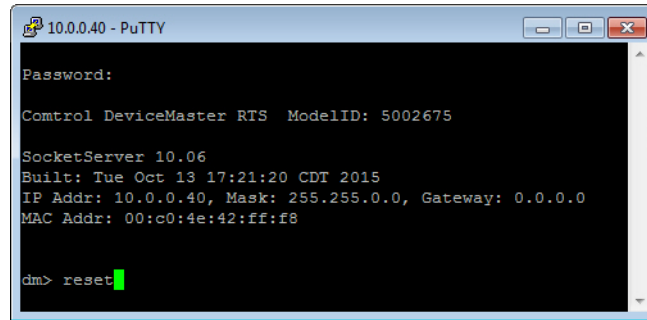

```

10.0.0.40 - PuTTY
Password:
Control DeviceMaster RTS ModelID: 5002675
SocketServer 10.06
Built: Tue Oct 13 17:21:20 CDT 2015
IP Addr: 10.0.0.40, Mask: 255.255.0.0, Gateway: 0.0.0.0
MAC Addr: 00:c0:4e:42:ff:f8
dm> reset
  
```

**Note:** The DeviceMaster UP does not come pre-programmed with a password.

3. Type **reset**, and close the session.
4. Open a new telnet session, enter the DeviceMaster UP IP address, and the password.
5. Type **dis** to disable the Bootloader.
6. Verify that the system responds with a **Loading disabled** message.

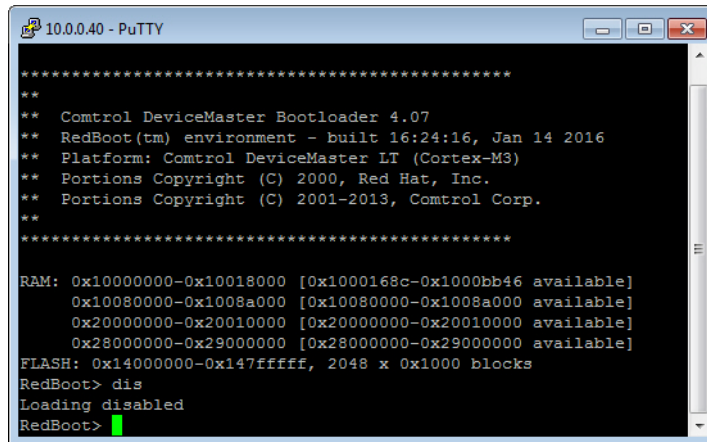

```

10.0.0.40 - PuTTY
*****
**
** Control DeviceMaster Bootloader 4.07
** RedBoot(tm) environment - built 16:24:16, Jan 14 2016
** Platform: Control DeviceMaster LT (Cortex-M3)
** Portions Copyright (C) 2000, Red Hat, Inc.
** Portions Copyright (C) 2001-2013, Control Corp.
**
*****
RAM: 0x10000000-0x10018000 [0x1000168c-0x1000bb46 available]
      0x10080000-0x1008a000 [0x10080000-0x1008a000 available]
      0x20000000-0x20010000 [0x20000000-0x20010000 available]
      0x28000000-0x29000000 [0x28000000-0x29000000 available]
FLASH: 0x14000000-0x147fffff, 2048 x 0x1000 blocks
RedBoot> dis
Loading disabled
RedBoot>
  
```

## Determining the Network Settings

### Default Network Settings

IP address:  
192.168.250.250

Subnet mask:  
255.255.0.0

Gateway address:  
192.168.250.1

If you are not sure what the network information is on a DeviceMaster UP, you can perform the following procedure.

1. Establish communications with the DeviceMaster UP using the serial (Page 68) or telnet (Page 69) method.
2. At the **RedBoot** prompt, type **ip**.

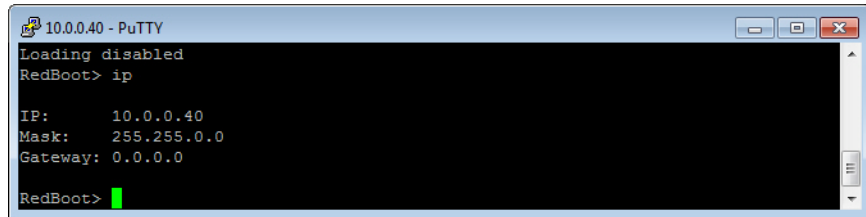

```

10.0.0.40 - PuTTY
Loading disabled
RedBoot> ip
IP:      10.0.0.40
Mask:    255.255.0.0
Gateway: 0.0.0.0
RedBoot>
  
```

The IP address, subnet mask, and IP gateway values will display.

**Note:** *Optionally, you can install PortVision DX on a Windows system on the network and see the IP information in the Device List pane.*

## Configuring the Network Settings

Use the following procedure to program the IP address using RedBoot.

1. Establish communications with the DeviceMaster UP using the serial (Page 68) or telnet (Page 69) method.
2. Enter **ip [addr mask gateway]** and press the **Enter** key to configure the IP address. *Where:*

*addr* = IP address you want to use

*mask* = matches you network subnet mask

*gateway* = assigned by your network administrator

*Make sure that each value is separated by a space.*

```

RedBoot>dis
Loading disabled
RedBoot> ip 192.168.11.152 255.255.0.0 192.168.0.254
RedBoot>
IP:      192.168.11.152
Mask:    255.255.00
Gateway: 192.168.0.254
RedBoot> reset
.. Resetting
  
```

3. Verify that RedBoot responds with your configured network information or reissue the command.
4. Type **reset** to reset the DeviceMaster UP, if you do not have any other related RedBoot tasks.

## Changing the Bootloader Timeout

Use the following procedure to change the Bootloader timeout value.

1. Establish communications with the DeviceMaster UP using the serial (Page 68) or telnet (Page 69) method.
2. At the **RedBoot** prompt, type **timeout**.

```
RedBoot> dis
Loading disabled
RedBoot> timeout
Timeout 15 seconds
RedBoot> timeout 45
timeout 45 seconds
RedBoot>_
```

RedBoot responds with the current Bootloader timeout value.

3. Type **timeout** and a value to change the timeout value. For example, **timeout 45** to change the Bootloader timeout to 45 seconds.

## Determining the Bootloader Version

Use the following procedure to determine what Bootloader version is loaded in the DeviceMaster UP.

1. Establish communications with the DeviceMaster UP using the serial (Page 68) or telnet (Page 69) method.
2. At the **RedBoot** prompt, type **version**.

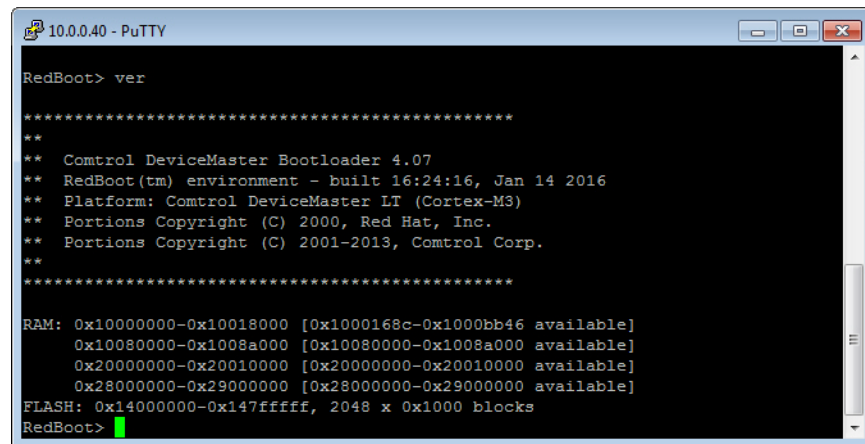

```
10.0.0.40 - PuTTY
RedBoot> ver
*****
**
** Control DeviceMaster Bootloader 4.07
** RedBoot(tm) environment - built 16:24:16, Jan 14 2016
** Platform: Control DeviceMaster LT (Cortex-M3)
** Portions Copyright (C) 2000, Red Hat, Inc.
** Portions Copyright (C) 2001-2013, Comtrol Corp.
**
*****
RAM: 0x10000000-0x10018000 [0x1000168c-0x1000bb46 available]
      0x10080000-0x1008a000 [0x10080000-0x1008a000 available]
      0x20000000-0x20010000 [0x20000000-0x20010000 available]
      0x28000000-0x29000000 [0x28000000-0x29000000 available]
FLASH: 0x14000000-0x147fffff, 2048 x 0x1000 blocks
RedBoot>
```

The Bootloader information displays.

3. Type **reset** to reset the DeviceMaster UP, if you do not have any other related RedBoot tasks.

**Note:** *Optionally, you can install PortVision DX on a Windows system on the network and see the Bootloader version in the Device List pane. Reboot the DeviceMaster UP, right-click the DeviceMaster UP and click Refresh Device until the Bootloader version is displayed for a few moments.*

---

## Resetting the DeviceMaster UP

---

When you have completed your tasks in RedBoot, you must enter a **reset** command at the **RedBoot>** prompt for the DeviceMaster UP to begin operation.

**Note:** The [LEDs](#) on the DeviceMaster UP will go through the power up sequence. The DeviceMaster UP has completed its reset cycle when the **Status LED** is lit and it stops flashing.

```
RedBoot> dis
Loading disabled
RedBoot> reset
```

---

## Configuring Passwords

---

This section discusses how to configure a password for the web and telnet server.

Use the following procedure to establish the DeviceMaster UP password for the Web and telnet server. Establishing a password prevents unauthorized changes to the DeviceMaster UP configuration.

1. Establish communications with the DeviceMaster UP using the serial (Page 68) or telnet method (Page 69).
2. Type **password [your\_password]** and press **Enter**.

**Note:** If you forget your password, you can reprogram the password using the serial method which bypasses the password.

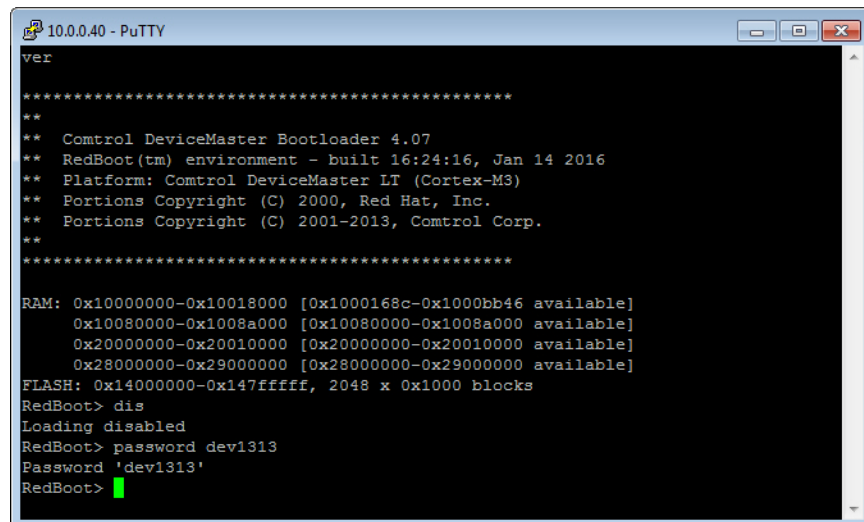

```
10.0.0.40 - PuTTY
ver
*****
**
** Control DeviceMaster Bootloader 4.07
** RedBoot(tm) environment - built 16:24:16, Jan 14 2016
** Platform: Comtrol DeviceMaster LT (Cortex-M3)
** Portions Copyright (C) 2000, Red Hat, Inc.
** Portions Copyright (C) 2001-2013, Comtrol Corp.
**
*****
RAM: 0x10000000-0x10018000 [0x1000168c-0x1000bb46 available]
      0x10080000-0x1008a000 [0x10080000-0x1008a000 available]
      0x20000000-0x20010000 [0x20000000-0x20010000 available]
      0x28000000-0x29000000 [0x28000000-0x29000000 available]
FLASH: 0x14000000-0x147fffff, 2048 x 0x1000 blocks
RedBoot> dis
Loading disabled
RedBoot> password dev1313
Password 'dev1313'
RedBoot>
```

**Note:** The Bootloader version on your DeviceMaster UP may be different than the version displayed in this graphic.

See the **auth** command in the [RedBoot Command Overview](#) on Page 73, if you want to set up Web browser authentication.



## RedBoot Command Overview

The following table is an overview of RedBoot commands available. After accessing RedBoot, you can review the list of commands online by entering **help** and pressing the **Enter** key.

For more detailed information, see the *eCos Reference Manual* that is located on the *Control Software and Documentation* CD or you can download it from: [http://downloads.comtrol.com/dev\\_mstr/UP/software/redboot/user\\_guide](http://downloads.comtrol.com/dev_mstr/UP/software/redboot/user_guide).

RedBoot Commands	
<b>auth</b> {noaccess, none, basic, md5, invalid}	Sets or displays web authentication. The default is set to <b>none</b> , which means that there is no authentication required to access the web server.  To deny access to the web server, click <b>noaccess</b> or <b>invalid</b> . If access is attempted, a message appears to notify the user that access is denied.  To configure the web server to request an un-encrypted password, click <b>basic</b> . To configure the web server to request an encrypted password, click <b>md5</b> . (Some browsers do not support the <b>md5</b> command.)
<b>baudrate [-b &lt;rate&gt;]</b>	Set/Query the system console baud rate.
<b>boardrev†</b>	Displays the board revision.
<b>cache [ON   OFF]</b>	Manages machine caches.
<b>channel [-l &lt;channel number&gt;]</b>	Displays or switches the console channel.
<b>chassis</b>	Displays chassis information.
<b>cksum -b &lt;location&gt; -l &lt;length&gt;</b>	Computes a 32-bit checksum [POSIX algorithm] for a range of memory.
<b>cpufreq</b>	Show/Set CPU clock frequency.
<b>delaycal &lt;passes&gt;</b>	Calibrate SDRAM clock delay.
<b>disable</b>	Disables automatic load of the default application.
<b>dump -b &lt;location&gt; [-l &lt;length&gt;] [-s] [-l]2 4]</b>	Displays (hex dump) of a range of memory.
<b>eepromvers [ver]</b>	Show/set EEPROM version.
<b>fis {cmds}</b>	Manages flash images. See Chapter 2 of the <a href="#">eCos Reference Manual</a> for {cmds} information.
<b>flash</b>	Shows flash information.
<b>go [-w &lt;timeout&gt;] [-c] [-n] [entry]</b>	Executes code at a location.
<b>help &lt;topic&gt;</b>	Displays available RedBoot commands.
<b>history</b>	Displays command history.
<b>hwflags [flags]</b>	Show/set hardware feature flags.
<b>ip [addr mask gateway]</b>	Displays or sets the IP address configuration.
<b>load [-r] [-v] [-h &lt;host&gt;] [-p &lt;TCP port&gt;] [-m &lt;varies&gt;] [-c &lt;channel_number&gt;] [-b &lt;base_address&gt;] &lt;file_name&gt;</b>	Loads a file from TFTP server or XModem.

<b>RedBoot Commands (Continued)</b>	
<code>loop 232 422 int port-number</code>	Runs loopback test on port. The DeviceMaster Serial Hub does not support this command.
<code>mac†</code>	Displays Ethernet MAC address.
<code>mcmp -s &lt;location&gt; -s &lt;location&gt; -d &lt;location&gt; -l &lt;length&gt; [-1 -2 -4]</code>	Compares two blocks of memory.
<code>mcopy -s &lt;location&gt; -d &lt;location&gt; -l &lt;length&gt; [-1 -2 -4]</code>	Copies memory from one address to another.
<code>mfill -b &lt;location&gt; -l &lt;length&gt; -p &lt;pattern&gt; [-1 -2 -4]</code>	Fills a block of memory with a pattern.
<code>model†</code>	Shows model number.
<code>numether [num]†</code>	Shows number of Ethernet ports.
<code>numserial [num]†</code>	Shows number of serial ports.
<code>oemid [id]†</code>	Shows OEM id.
<code>password {password}</code>	Sets or deletes the password.
<code>ping [-v] [-n &lt;count&gt; -l &lt;length&gt;] [-t &lt;timeout&gt; -r &lt;rate&gt;] [-i &lt;IP_addr&gt;] -h &lt;IP_addr&gt;</code>	Network connectivity test.
<code>ramtest &lt;passes&gt;</code>	Test the RAM.
<code>ramtime [reg [&lt;value&gt;]]</code>	Shows RAM timing register values.
<code>reset</code>	Resets the DeviceMaster UP.
<code>secureconf [disable enable]</code>	Sets or displays secure config enable.
<code>securedata [disable enable]</code>	Sets or displays secure data enable.
<code>sernum [prefix] [serial_number] sernum [serial_number]†</code>	Displays device serial number (if available).
<code>?</code>	Displays short help.
<code>snmp [disable enable]</code>	Sets or displays SNMP enable.
<code>summary</code>	Displays a summary that includes the bootloader version, network address information, MAC address, and security settings.
<code>telnet [disable   enable]</code>	Sets or displays telnet server enable. Disables telnet.
<code>tetimeout [seconds]</code>	Shows or sets telnet time-out.
<code>terse</code>	Terse command response mode.
<code>t485 port #1 port #2</code>	Runs port-to-port RS-485 test. This is not available on the DeviceMaster Serial Hub. Port numbering is Port 0 through 15 and you must connect a straight-through cable such as Ethernet patch cord.
<code>timeout {seconds}</code>	Displays or sets Bootloader time-out value.
<code>version</code>	Displays RedBoot version information.
<code>x -b &lt;location&gt; [-l &lt;length&gt;] [-s] [-1 2 4]</code>	Displays (hex dump) a range of memory.
<code>kszdump</code>	Dumps a pre-determined set of KSZ8863 registers















<b>RedBoot Commands (Continued)</b>	
<b>kszrd &lt;r1&gt; [r2]</b>	Reads specified KSZ8863 registers.
<b>kszrestart</b>	Restarts KSZ8863.
<b>kszwr &lt;r1&gt; &lt;val&gt;</b>	Reads specified KSZ8863 registers.
<i>† Read-only items that you cannot change in Redboot.</i>	



# Hardware Specifications

## Locating DeviceMaster UP Specifications

Specifications can be found on the Control web site at the following addresses.

Product	Ports	Connector/Number of Ethernet Ports	Specification Web Page
DeviceMaster UP VDC Panel Mount	1	DB9/1E	
DeviceMaster UP VDC Panel Mount Modbus	1	DB9/1E	
DeviceMaster UP DIN Rail	1	DB9/1E	
DeviceMaster UP DIN Rail	1	Terminal Block	
DeviceMaster UP	2	DB9/1E	
DeviceMaster UP Modbus	2	DB9/1E	
DeviceMaster UP	2	DB9/2E	
DeviceMaster UP Modbus	2	DB9/2E	
DeviceMaster UP	2	Screw Terminals/1E	
DeviceMaster UP Modbus	2	Screw Terminals/1E	
DeviceMaster UP	2	Screw Terminals/2E	
DeviceMaster UP Modbus	2	Screw Terminals/2E	
DeviceMaster UP (DIN Rail)	4	DB9/2E	
DeviceMaster UP	4	DB9/2E	
DeviceMaster UP Modbus	4	DB9/2E	

## External Power Supply Specifications

This subsection discusses information that you may need if you wish to use your own external power supplies.

- [1-Port Panel Mount 5-30VDC Power Supply](#) on Page 78
- [2-Port \(Serial Terminals\) Power Supply](#) on Page 79
- [2-Port \(Serial Terminals\) Power Supply](#) on Page 79
- [2-Port \(DB9\) Power Supply](#) on Page 80
- [4-Port DIN Rail Models Power Supply](#) on Page 80
- [4-Port Panel Mount Power Supply](#) on Page 81

### 1-Port Panel Mount 5-30VDC Power Supply

This table provides specifications for the power supply shipped with the DeviceMaster UP 1-port panel mount.

<b>Control Power Supply: 1-Port 5-30VDC</b>	
Input line frequency	43-63 Hz
Input line voltage	90-260 VAC
Output voltage	24VDC
Output current	500 mA @ 24VDC

This table provides the specifications, if you intend on using your own power supply.

<b>1-Port 5-30VDC External Power Supply</b>	
Output voltage†	5-30VDC
Current†	100 mA (Min) @ 24VDC
Power	2.5 W
† Any power supply that meets current consumption, voltage, power, and connector pinouts requirements can be used.	

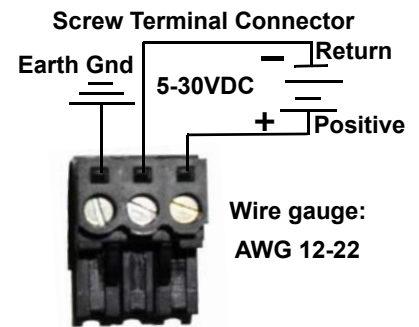

**1-Port DIN Rail Power Supply**

This table provides the specifications to purchase a power supply for a DeviceMaster UP 1-port DIN rail.

<b>1-Port DIN Rail External Power Supply</b>	
Output voltage†	5-30VDC
Current†	100 mA (Min) @ 24VDC
Power	2.5 W
† Any power supply that meets current consumption, voltage, power, and connector pinouts requirements can be used.	

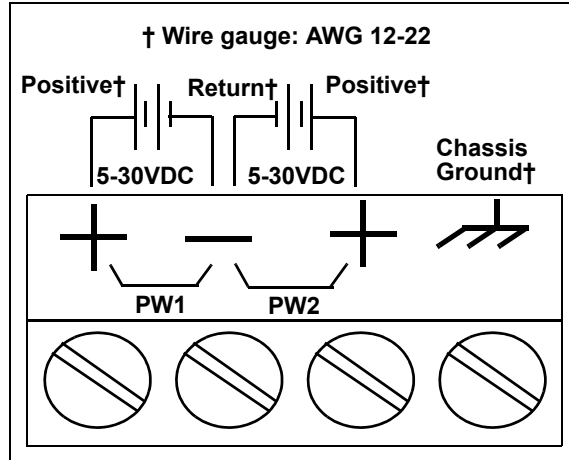

**2-Port (Serial Terminals) Power Supply**

This table provides the specifications to purchase a power supply for a DeviceMaster UP 2-port with serial terminals DIN rail.

<b>2-Port (Serial Terminals) DIN Rail External Power Supply</b>	
Output voltage†	5-30VDC
Current†	100 mA (Min) @ 24VDC
Power	2.5 W
† Any power supply that meets current consumption, voltage, power, and connector pinouts requirements can be used.	

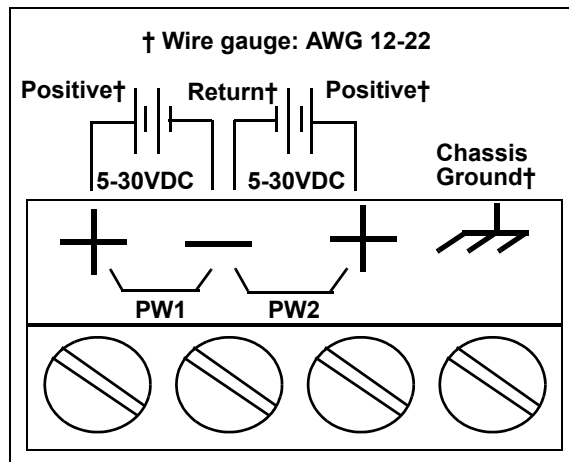

**2-Port (DB9) Power Supply**

This table provides the specifications to purchase a power supply for a DeviceMaster UP 2-port 1E/2E models with DB9 connectors.

<b>2-Port DB9 Models External Power Supply</b>	
Output voltage†	6-30VDC
Current†	100 mA (Min) @ 24VDC
Power	2.5 W
† Any power supply that meets current consumption, voltage, power, and connector pinouts requirements can be used.	

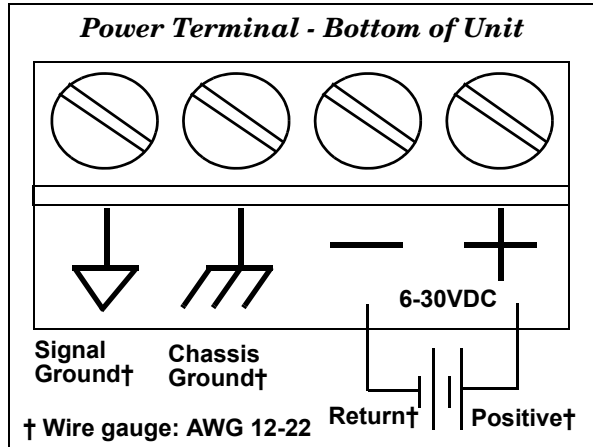

**4-Port DIN Rail Models Power Supply**

This table provides the specifications to purchase a power supply for a DeviceMaster UP 4-port (DIN rail).

<b>4-Port DIN Rail External Power Supply</b>	
Output voltage†	5-30VDC
Current†	100 mA (Min) @ 24VDC
Power	2.5 W
† Any power supply that meets current consumption, voltage, power, and connector pinouts requirements can be used.	

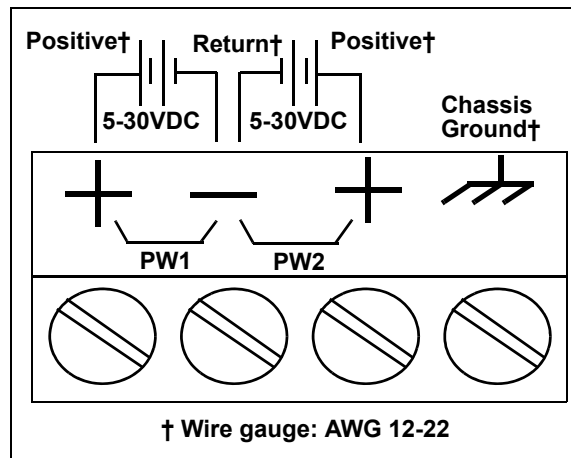



**4-Port Panel Mount Power Supply**

This table provides the specifications for the power supply shipped with the DeviceMaster UP 4-port.

<b>Control Power Supply: 4-Port</b>	
Input line frequency	47 - 63 Hz
Input line voltage	90 - 260 VAC
Output voltage	24VDC
Output current	500 mA @ 24VDC

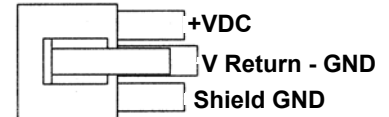

Housing Molex P/N:  
39-01-4030  
Pins Molex P/N:  
44485-1211

This table provides the specifications, if you intend on using your own power supply.

<b>External Power Supply: 4-Port</b>	
Output voltage†	9-30VDC
Current†	200 mA (Min) @ 24VDC
Power	4.8 W
† Any power supply that meets current consumption, voltage, power, and connector pinouts requirements can be used.	

**DeviceMaster UP Product Pictures**

This subsections provides you with detailed pictures of the different DeviceMaster UP models:

- [1-Port \(DB9\)](#) on Page 81
- [2-Port \(Serial Terminals\) Power Supply](#) on Page 79
- [2-Port Terminal Block \(Dual Ethernet Ports\)](#) on Page 83
- [2-Port DB9 \(Single Ethernet Port\)](#) on Page 83
- [2-Port DB9 \(Dual Ethernet Ports\)](#) on Page 84
- [4-Port \(DB9\)](#) on Page 84

**1-Port (DB9)**

This illustrates the DeviceMaster UP 1-Port.



See [DeviceMaster UP LEDs](#) on Page 89 for information about the LEDs.

**1-Port DIN Rail  
(Screw Terminal)**

This illustrates the 1-port DIN rail screw terminal model.

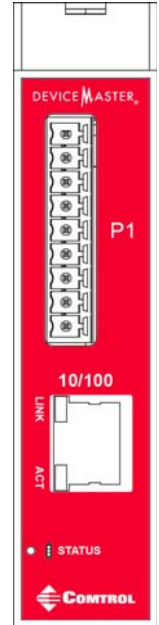

**1-Port DIN Rail  
(DB9)**

This illustrates the 1-port DIN rail DB9 model.



**2-Port Terminal Block (Single Ethernet Port)**

The DeviceMaster UP 2-port 1E with serial terminals uses a 6-30VDC power supply. See [2-Port \(DB9\) Power Supply](#) on Page 80 for information about the power supply.



**2-Port Terminal Block (Dual Ethernet Ports)**

The DeviceMaster UP 2-port 2E with serial terminals uses a 6-30VDC power supply. See [2-Port \(DB9\) Power Supply](#) on Page 80 for information about the power supply.



**2-Port DB9 (Single Ethernet Port)**

The DeviceMaster UP 2-port 1E DB9 uses a 6-30VDC power supply. See [2-Port \(DB9\) Power Supply](#) on Page 80 for information about the power supply.



**2-Port DB9 (Dual Ethernet Ports)**

The DeviceMaster UP 2-port 2E DB9 uses a 6-30VDC power supply. See [2-Port \(DB9\) Power Supply](#) on Page 80 for information about the power supply.



**4-Port DIN Rail (DB9)**

The DeviceMaster UP 4-port 2E DB9 uses a 5-30VDC power supply. See [4-Port DIN Rail Models Power Supply](#) on Page 80 for information about the power supply.

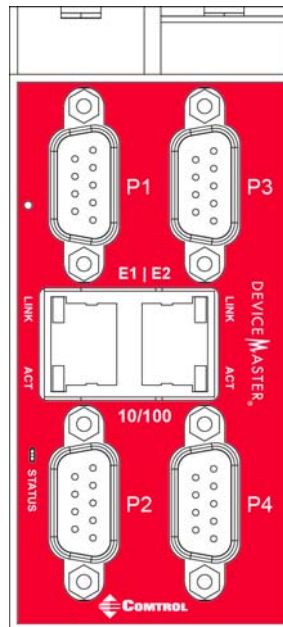

**4-Port (DB9)**

The PWR LED for the DeviceMaster UP 4 with DB9 ports is on the other side of the unit. See [DeviceMaster UP LEDs](#) on Page 89 for information about the LEDs.



# Troubleshooting and Technical Support

This section contains troubleshooting information for your DeviceMaster UP. You may want to review the following subsections before calling Technical Support because they will request that you perform many of the procedures or verifications before they will be able to help you diagnose a problem.

- [Troubleshooting Checklist](#) on Page 85
- [General Troubleshooting](#) on Page 87
- [Daisy-Chaining DeviceMaster UP 2E/4-Port Units](#) on Page 88
- [DeviceMaster UP LEDs](#) on Page 89

If you cannot diagnose the problem, you can contact [Technical Support](#) on Page 91.

## Troubleshooting Checklist

---

---

The following checklist may help you diagnose your problem:

- Verify that you are using the correct types of cables on the correct connectors and that all cables are connected securely.

**Note:** *Most customer problems reported to Control Technical Support are eventually traced to cabling or network problems.*

Model	Connected to	Ethernet Cable	Connector Name
1-Port	Ethernet hub or NIC	Standard	10/100 ETHERNET
1-Port Embedded	Ethernet hub or NIC	Standard	RJ45 port (not labeled)
2-Port - 1E (Single Ethernet Port)	Ethernet hub or NIC	Standard	10/100
2-Port - 2E (Dual Ethernet Ports)	Ethernet hub or NIC	Standard	10/100 - E1/E2
4-Port	NIC	Standard	DOWN
	Ethernet hub	Standard	UP

- Verify that the network IP address, subnet mask, and gateway is correct and appropriate for the network. Make sure that the IP address programmed into the DeviceMaster UP matches the unique reserved IP configured address assigned by the system administrator.
  - If IP addressing is being used, the system should be able to ping the DeviceMaster UP.
  - If using DHCP, the host system needs to provide the subnet mask and gateway.
- Verify that the Ethernet hub and any other network devices between the system and the DeviceMaster UP are powered up and operating.
- Reboot the system, then reset the power on the DeviceMaster UP and watch the **PWR** or **Status** (Page 89) light activity.

<b>PWR or Status LED</b>	<b>Description</b>
5 sec. off, 3 flashes, 5 sec. off, 3 flashes...	RedBoot™ checksum failure.
5 sec. off, 4 flashes, 5 sec. off, 4 flashes...	SREC load failure.

- If you have a spare DeviceMaster UP, try replacing the device.

## General Troubleshooting

This table illustrates some general troubleshooting tips.

**Note:** Make sure that you have reviewed the [Troubleshooting Checklist](#) on Page 85.

General Condition	Explanation/Action
PWR or Status LED flashing	<p>Indicates that boot program has not downloaded to the unit.</p> <ol style="list-style-type: none"> <li>1. Reboot the system.</li> <li>2. Make sure that you have downloaded the most current firmware for your <a href="#">protocol</a>.</li> </ol> <p><b>Note:</b> If the PWR or Status LED is still flashing, contact Technical Support.</p>
PWR or Status LED not lit	<p>Indicates that power has not been applied or there is a hardware failure. Contact Technical Support.</p>
Cannot ping the device through Ethernet hub	<p>Isolate the DeviceMaster UP from the network. Connect the device directly to the NIC in the host system.</p>
Cannot ping or connect to the DeviceMaster UP	<p>The default DeviceMaster UP IP address is often not accessible due to the subnet masking from another network unless <b>192.168</b> is used in the network.</p> <p>In most cases, it will be necessary to program in an address that conforms to your network.</p>
DeviceMaster UP continuously reboots when connected to some Ethernet switches or routers	<p>Invalid IP information may also cause the switch or router to check for a gateway address. Lack of a gateway address is a common cause.</p>

## Daisy-Chaining DeviceMaster UP 2E/4-Port Units

---

---

The DeviceMaster UP 2E/4-port models with external power supplies follow the IEEE specifications for standard Ethernet 10/100BASE-TX topologies.

When using the **UP** and **DOWN** ports, the DeviceMaster UP 2E/4 is classified as a switch. When using the **UP** port only, it is a simple end node device.

The maximum number of daisy-chained DeviceMaster UP 2E/4 units, and the maximum distance between units is based on the Ethernet standards and will be determined by your own environment and the conformity of your network to these standards.

Control has tested with seven DeviceMaster UP 2E/4 units daisy-chained together using 10 foot CAT5 cables, but this is not the theoretical limit. You may experience a performance hit on the devices at the end of the chain, so it is recommended that you overload and test for performance in your environment. The OS and the application may also limit the total number of ports that may be installed.

Following are some quick guidelines and URLs of additional information. Note that standards and URLs do occasionally change.

- Ethernet 10BASE-T Rules
  - The maximum number of repeater hops is four.
  - You can use Category 3 or 5 twisted-pair 10BASE-T cables.
  - The maximum length of each cable is 100m (328ft).

***Note:** Category 3 or 5 twisted pair cables look the same as telephone cables but they are not the same. The network will not work if telephone cables are used to connect the equipment.*
- Fast Ethernet 100BASE-TX rules
  - The maximum number of repeater hops is two (for a Class II hub). A Class II hub can be connected directly to one other Class II Fast Ethernet hub. A Class I hub cannot be connected directly to another Fast Ethernet hub.
  - You must use Category 5 twisted-pair 100BASE-TX cables.
  - The maximum length of each twisted-pair cable is 100m (328ft).
  - The total length of twisted-pair cabling (across directly connected hubs) must not exceed 205m (672ft).

***Note:** Category 5 twisted pair cables look the same as telephone cables but they are not the same. The network will not work if telephone cables are used to connect the equipment.*
- IEEE 802.3 specification: A network using repeaters between communicating stations (PCs) is subject to the 5-4-3 rule of repeater placement on the network:
  - Five segments connected on the network.
  - Four repeaters.
  - Three segments of the 5 segments can have stations connected. The other two segments must be inter-repeater link segments with no stations connected.

Additional information may be found at <http://compnetworking.about.com/cs/ethernet1/> or by searching the web.



## DeviceMaster UP LEDs

The DeviceMaster UP has network and port LEDs to indicate status. This subsection discusses:

- [TX/RX LEDs](#)
- [Network and Device LEDs](#) on Page 89

### TX/RX LEDs

This subsection discusses RX and TX LEDs on the DeviceMaster UP 4-port.

**Note:** *The DeviceMaster UP 1-port and 2-port models do not have TX/RX LEDs.*

The RX (yellow) and TX (green) LEDs function accordingly when the cable is attached properly to a serial device.

- After power cycling the DeviceMaster UP, the RX/TX LEDs are off.
- The LEDs do not function as described until the port has been opened by an application.
  - If the port is configured for RS-232/422 mode:
    - RX LEDs (yellow) are lit
    - TX LEDs (green) are lit when as the data exits the port
  - If the port is configured for RS-485 mode:
    - RX LEDs (yellow) are lit while receiving
    - TX LEDs (green) are lit during active data transmission

### Network and Device LEDs

The LEDs indicate that the default DeviceMaster UP application is running. If you have loaded PortVision DX, you can check the DeviceMaster UP status online.

Ports	Model	Network LEDs
1 Panel Mount	DeviceMaster UP	<ul style="list-style-type: none"> <li>• The <b>Status</b> LED on the front of the unit is lit, which indicates that it has power and has completed the boot cycle. <b>Note:</b> <i>The Status LED flashes while booting and it takes approximately 15 seconds for the bootloader to complete the cycle. When the Bootloader completes the cycle, the LED has a solid, steady light that blinks approximately every 10 seconds.</i></li> <li>• The red <b>Link Act</b> LED is lit, which indicates a working Ethernet connection.</li> <li>• If the red <b>Duplex</b> LED is lit, it indicates full-duplex activity.</li> <li>• If the red <b>100</b> LED is lit, it indicates a working 100 MB Ethernet connection (100 MB network, only).</li> </ul>
1 DIN Rail	DeviceMaster UP	<ul style="list-style-type: none"> <li>• The <b>Status</b> LED on the front of the unit is lit, which indicates that it has power and has completed the boot cycle. <b>Note:</b> <i>The Status LED flashes while booting and it takes approximately 15 seconds for the bootloader to complete the cycle. When the Bootloader completes the cycle, the LED has a solid, steady light that blinks approximately every 10 seconds.</i></li> <li>• If the <b>LINK</b> (green) LED is lit, it indicates a working Ethernet connection.</li> <li>• If the <b>ACT</b> (yellow) LED flashes, it indicates network activity.</li> </ul>

Ports	Model	Network LEDs
2	DeviceMaster UP	<ul style="list-style-type: none"> <li>• The <b>STATUS LED</b> on the device is lit, indicating you have power and it has completed the boot cycle. <i>Note: The STATUS LED flashes while booting and it takes approximately 15 seconds for the Bootloader to complete the cycle. When the Bootloader completes the cycle, the LED has a solid, steady light that blinks approximately every 10 seconds.</i></li> <li>• If the <b>LINK</b> (green) LED is lit, it indicates a working Ethernet connection.</li> <li>• If the <b>ACT</b> (yellow) LED flashes, it indicates network activity.</li> </ul>
4 DIN Rail	DeviceMaster UP	<ul style="list-style-type: none"> <li>• The <b>STATUS LED</b> on the device is lit, indicating you have power and it has completed the boot cycle. <i>Note: The STATUS LED flashes while booting and it takes approximately 15 seconds for the Bootloader to complete the cycle. When the Bootloader completes the cycle, the LED has a solid, steady light that blinks approximately every 10 seconds.</i></li> <li>• If the <b>LINK</b> (green) LED is lit, it indicates a working Ethernet connection.</li> <li>• If the <b>ACT</b> (yellow) LED flashes, it indicates network activity.</li> </ul>
4	DeviceMaster UP†	<ul style="list-style-type: none"> <li>• The <b>PWR LED</b> on the front of the unit is lit, which indicates it has power and has completed the boot cycle. <i>Note: The PWR LED flashes while booting and it takes approximately 15 seconds for the bootloader to complete the cycle. When the Bootloader completes the cycle, the LED has a solid, steady light that blinks approximately every 10 seconds.</i></li> <li>• The red <b>LNK/ACT</b> LED is lit, which indicates a working Ethernet connection.</li> <li>• If the red <b>100</b> LED is lit, it indicates a working 100 MB Ethernet connection (100 MB network, only).</li> </ul>
† External power supply.		

## Technical Support

---



---

If you are using an NS-Link driver for a Windows system, you should review the troubleshooting section in the *DeviceMaster UP Device Driver (NS-Link) User Guide for Windows* (Page 12) before contacting Technical Support.

It contains troubleshooting procedures that you should perform before contacting Technical Support since they will request that you perform, some or all of the procedures before they will be able to help you diagnose your problem. If you need technical support use one of the following methods.

<b>Control Contact Information</b>	
Downloads (FTP)	<a href="ftp://ftp.control.com/html/up_main.htm">ftp://ftp.control.com/html/up_main.htm</a>
Downloads (HTTP)	<a href="http://downloads.control.com/html/default.htm">http://downloads.control.com/html/default.htm</a>
Web site	<a href="http://www.control.com">http://www.control.com</a>
Phone	(763) 957-6000

